

**PRIMA**® OFFICIAL GAME GUIDE

PUZZLE SOLUTIONS ✓  
UNSEEN CONCEPT ART ✓  
EXCLUSIVE BACKSTORY ✓

ONLY FOR THE PC!

Visit us online at [primagames.com](http://primagames.com)

# MYST

---

## IV

---

# REVELATION



UBISOFT

This game has received the following rating from the ESRB



# MYST<sup>IV</sup> REVELATION

## PRIMA OFFICIAL GAME GUIDE

BRYAN STRATTON AND MARY DEMARLE

PRIMA GAMES

A DIVISION OF RANDOM HOUSE, INC.

3000 LAVA RIDGE COURT

ROSEVILLE, CA 95661

1-800-733-3000



The Prima Games logo is a registered trademark of Random House, Inc., registered in the United States and other countries. Primagames.com is a registered trademark of Random House, Inc., registered in the United States.

©2004 by Prima Games. All rights reserved. No part of this book may be reproduced or transmitted in any form or by any means, electronic or mechanical, including photocopying, recording, or by any information storage or retrieval system without written permission from Prima Games. Prima Games is a division of Random House, Inc.

Product Manager: Damien Waples

Project Editor: Fernando Bueno

Design: Kari Keating

Prima would like to send a very special thanks to Alexandre Dessaint at Ubisoft for all of his help on this project.

©2004 Ubisoft Entertainment. All Rights Reserved. Ubisoft, ubi.com, and the Ubisoft logo are trademarks of Ubisoft Entertainment in the U.S. and/or other countries. D'ni (TM), Cyan®, and Myst® are trademarks of Cyan, Inc. and Cyan Worlds, Inc. under license to Ubisoft Entertainment.

All products and characters mentioned in this book are trademarks of their respective companies.

Please be advised that the ESRB rating icons, "EC", "K-A", "E", "T", "M", "AO" and "RP" are copyrighted works and certification marks owned by the Entertainment Software Association and the Entertainment Software Rating Board and may only be used with their permission and authority. Under no circumstances may the rating icons be self-applied or used in connection with any product that has not been rated by the ESRB. For information regarding whether a product has been rated by the ESRB, please call the ESRB at 1-800-771-3772 or visit [www.esrb.org](http://www.esrb.org). For information regarding licensing issues, please call the ESA at (212) 223-8936. Please note that ESRB ratings only apply to the content of the game itself and does NOT apply to the content of this book.

### Important:

Prima Games has made every effort to determine that the information contained in this book is accurate. However, the publisher makes no warranty, either expressed or implied, as to the accuracy, effectiveness, or completeness of the material in this book; nor does the publisher assume liability for damages, either incidental or consequential, that may result from using the information in this book. The publisher cannot provide information regarding game play, hints and strategies, or problems with hardware or software. Questions should be directed to the support numbers provided by the game and device manufacturers in their documentation. Some game tricks require precise timing and may require repeated attempts before the desired result is achieved.

ISBN: 0-7615-4911-0

Library of Congress Catalog Card Number: 2004112023

## Contents

<i>Tomahna, Part One</i> .....	2
<i>Tomahna, Part Two</i> .....	17
<i>Spire</i> .....	32
<i>Tomahna, Part Three</i> .....	68
<i>Serenia, Part 1</i> .....	79
<i>Tomahna, Part Four</i> .....	102
<i>Haven</i> .....	107
<i>Tomahna, Part Five</i> .....	148
<i>Serenia, Part Two</i> .....	152
<i>Journals</i> .....	183

# Tomahna, Part One

//

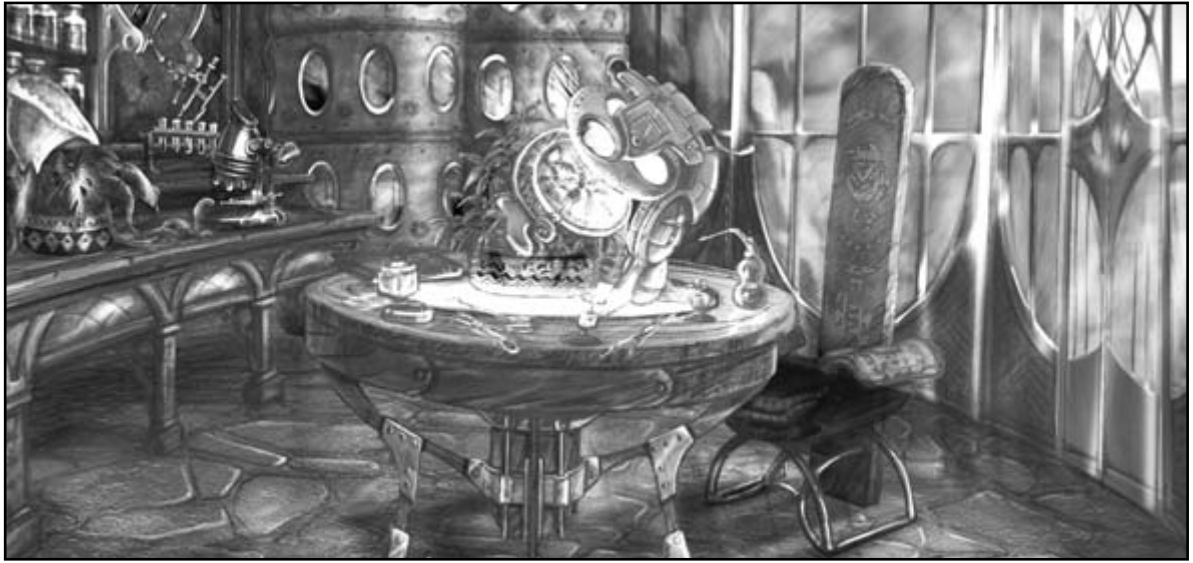

## THE LETTER

It embarrasses me to admit it, but until his letter showed up, I hadn't thought of my friend Atrus in some time. In retrospect, that strikes me as strange, as Atrus is without a doubt one of the most unique persons I've ever met. Not only has he shown me wonders undreamt of in all of creation, he also claims to have been born to an all but extinct race of people—the D'ni—who lived in a cavern at the center of the earth.

I admit that when he first shared this shocking knowledge with me, the thought crossed my mind that I might have placed my soul in jeopardy by communicating with a demon, or perhaps even the Devil himself in human form. With a laugh, Atrus dispelled this notion, chiding me for holding such beliefs while claiming to live in an "Age of Reason."

Anyone who has had the pleasure of meeting Atrus would think me foolish for even momentarily considering that my kind-hearted friend could possibly be a diabolic agent. However, having witnessed so many fantastic events and devices since first meeting Atrus and his family—flora and fauna like none seen on earth, locomotive machines of all descriptions, and books that opened doorways to other worlds (or

Ages)—I hope that my readers will forgive me this speck of superstitious fear. In truth, Atrus is a man of reason like myself, constantly marveling at the minute details of the infinite Ages he has been blessed with the ability to visit.

His life has not been an easy one, however. Born to a lost race he never met and raised by a father jealous of his superior intellect, Atrus's one constant companion has been his loving wife Catherine. But even this union has produced its share of heartache. Atrus was forced to imprison their sons, Sirrus and Achenar, in Prison Ages because of their abuse of the peoples of various Ages. And not only did he jail them, he destroyed the Linking Books that led to the Ages, incarcerating them for all time.

Or so I was led to believe. Twenty years after our first meeting, twenty years after Atrus destroyed Sirrus and Achenar's Prison Age Linking Books on Myst Island, I received a letter from him.

*For twenty years, I've harbored a secret. People talk about my sons and the evil things they did, but still I remain strangely mute. I do not discuss my own actions that day, or the rage I felt when I burned the two Linking Books that had snared them. Some people believe my sons died in those fires, but the truth is, they did not.*

*You're the only one I can confide in, my friend. So I'm asking you to come to Tomahna. There are things I must tell you about my sons.*

What choice did I have? How could I ignore a friend in need, a man who desperately wanted to break his long silence on a topic that I knew had weighed heavily on his heart? Without hesitation, I made arrangements to meet Atrus in his current home in the caverns of the North American desert, which he called Tomahna.



### *The House that No One Can Find*

*Members of the D'ni Restoration Council (DRC) have long debated the whereabouts of Tomahna, the beautiful desert oasis where Atrus and Catherine built their second home. At first, many believed Tomahna to be an Age unto itself, and countless hours were spent combing D'ni cavern, searching for the lost descriptive book.*



*Then in 1999, a young researcher noticed a trend in Atrus and Catherine's journals. Neither husband nor wife ever referred to Tomahna as an Age; it was simply their "Home." Could it be that Tomahna was not a world Atrus had written, but a series of buildings constructed here on Earth?*

*Today, several canyon regions in and around New Mexico have been tagged for investigation. If indeed Tomahna does exist on Earth, its exact site may never be found, since the face of the desert has changed so much over time. The beautiful river that fed Tomahna's lake has either shifted course or dried up altogether. It may even have washed Tomahna away, leaving only scattered pieces beneath the desert soil.*

### **MEETING YEESHA**

Upon my arrival, I was met by Atrus and Catherine's daughter, Yeesha, who came to retrieve me in a locomotive device of Atrus's own design. Yeesha gleefully admitted that her mother was not present on Tomahna at the time, or Yeesha would never have been allowed to pilot the craft by herself.



*Yeesha, daughter of Atrus and Catherine*

As we traveled to meet her father, I looked at Yeesha and marveled inwardly at how much she had grown since last I saw her. I knew that it was common for the D'ni, Atrus's ancestors, to live three centuries or more, but Yeesha seemed to be maturing as quickly as a human child. Already I could see in the girl next to me hints of the woman she would become, a perfect product of her father's rational intellect and her mother's intuitive creativity.

Yeesha stopped the rail car as we approached the family's settlement and encouraged me to take a picture of it with the image device Atrus had given me as a gift during my last visit. I fumbled with the contraption and took my first picture of the misty waterfall ahead of us. (I confess that I hadn't used the device previously, hoping to avoid awkward questions from my peers as to what it was or where it came from.)



*Photographing Tomahna with my image recorder*

Fortunately, I managed to figure out how to use the camera quickly. It was plain to see that while Yeesha was willing to indulge me in an opportunity to photograph Tomahna, she was not about to wait very long for me to do it. Whether this was due to the natural impatience of youth or the urgings of her father, I did not know. The camera's shutter clicked, and I placed the image in my journal as Yeesha started the rail car moving once again.



*I pulled this lever to open the door to Atrus's laboratory.*

We arrived at our destination, a small dock of sorts outside of Atrus's laboratory. Yeesha shut down the rail car and exited, pulling a lever to the right of the circular laboratory door to open it. Stepping into the laboratory, she encouraged me to do the same.



### ATRUS'S LABORATORY



*The laboratory was a collection of wondrous experiments.*

Atrus greeted me warmly, expressing his hope that Yeessa's driving wasn't too erratic. This modest attempt at humor, made by a man unaccustomed to joking, only underscored an obvious discomfort lying just under the surface.

Quickly getting down to business, Atrus told me that he needed my help. My pulse quickened. Although I had seen Atrus socially on many occasions, we had only had three conversations that began this way in our 20-year friendship. The first was at the end of my initial visit to Myst Island, just before Atrus burned the Linking Books to the Prison Ages where he'd confined his sons. The second was prior to my first visit to Catherine's home Age of Riven, when Atrus asked me for help in rescuing her from his father, Gehn. The third time was after Saavedro, a victim of Sirrus and Achenar's recklessness, threatened to destroy the descriptive book for the Age of Releeshahn. I felt that a fourth great adventure was about to begin.

Atrus stunned me by saying that, although he had destroyed the Linking Books to his sons' Prison Ages, he and Catherine were debating whether or not to release them from their imprisonment. (So there was another way out of the Ages.) Catherine felt that they had been sufficiently rehabilitated, but Atrus was unconvinced. Ever the scientist, he required an objective opinion, and he did me more honor than he knew by telling me that I was the only person he could trust to give him that.

As always, I found Atrus's laboratory to be filled with fantastic objects. Bolts of electricity crackled around the room, and the desk was littered with tools and devices I'd never seen. Atrus had been busy. I casually opened a few drawers and cabinets as I walked farther into the laboratory but shut them quickly when I realized that their owner was present.



*Atrus needed my help.*

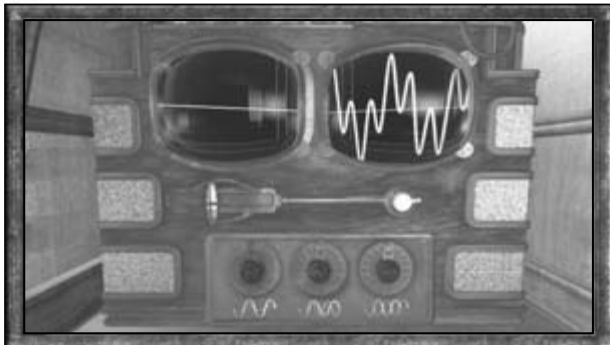

*The controls for the Crystal Viewer—the slider switched between two different frequencies, and the dials at the bottom (from left to right) adjusted the amplitude, frequency, and phase of the waveforms.*

it. A slider below the left monitor switched between our two frequencies, and three dials at the bottom of the device adjusted the amplitude or volume (left dial), frequency or speed (center dial), and phase (right dial) of our waveform.

I confess that the science of the Crystal Viewer was far beyond my limited comprehension. I simply followed Atrus's instructions to the letter, and after some trial and error, we tuned the Crystal Viewer to Haven's waveform. We then began work on replicating the waveform unique to Spire, SIRRUS's Prison Age. This one proved to be more difficult, but by following Atrus's instructions carefully, we eventually tuned it correctly.



*An explosion rocked the laboratory.*

As Atrus left the laboratory, he turned to me and made one more request. "Keep an eye on Yeesha, would you?" He tried to make it sound offhand, but I could tell that some disturbing thought had cast a shadow across his mind.

Atrus turned to point out a device he called the Crystal Viewer. He'd shown me this contraption before, but he had obviously made some extensive modifications to it. He asked that I assist him in tuning the Crystal Viewer so that we could monitor the Prison Ages.

We began by tuning the Crystal Viewer to create a waveform that matched the one emitted by Haven, Achenar's Prison Age. The tuning device had two monitors—the left one displayed the two frequencies we were working with, and the right one showed Haven's waveform (an orange line) with our waveform (a blue line) superimposed on

As soon as we finished tuning both Ages' waveforms, the Crystal Viewer suffered an explosion, rendering it temporarily unusable. After looking at it, Atrus decided he needed to retrieve some replacement parts from the Rime Age and some tools from the Cleft where he was raised.

The explosion cut the main power to Tomahna, and Atrus requested that I restart it by reactivating the waterwheel in the complex. I could then contact him in the Rime Age by activating the antenna on the roof and using the information in his journal to contact Rime.



## *The Crystal Viewer Explosion—What Really Went Wrong?*

*A rather interesting controversy has arisen in recent months, ever since translated copies of this "Personal Travel Journal" began circulating among DRC members. It seems that discrepancies exist between the stranger's version of events and those described in one of Atrus's journals.*

*Was the stranger somehow responsible for the explosion that caused the Crystal Viewer to short-circuit? Atrus's version implies he had to prompt his old friend twice to continue working—a fact conveniently not mentioned in the stranger's description.*

*"It was during my second request," Atrus's journal entry states, "that the movable eye attachment exploded behind me." This statement has led several DRC members to blame the malfunction on the stranger's inaction, rather than on Atrus's faulty wiring.*

*Doubtless, we will never know the truth.*



## RESTORING POWER

Restoring power to Tomahna required me not only to find the energy control panel but to understand exactly what I was restoring power to.

## The Gardens



*I pulled the lever to open the elevator door.*



*I moved the left handle in the elevator to the center position to move to the level below me.*



*The right handle in the elevator opened the door.*

From my previous visits to Tomahna, I recalled that I'd have to pass through Catherine's gardens outside of her study to reach the waterwheel. I pulled the lever near the Crystal Viewer to open the nearby elevator door and stepped into the elevator. Once inside, I set the left lever to its center position to descend one level. When the elevator came to a stop, I pulled the right lever to open the door and stepped onto the wooden walkway that led to the gardens.





*Catherine's gardens*



*A ladder leading down inside the first garden*

Not being in any particular hurry, I entered the first of Catherine's two gardens and descended the ladder at the entrance. Atrus once confessed to me that he found the nurturing of plant life, with all of its imprecise variables, to be more frustrating than it was worth. Catherine, however, obviously delighted in it, and her lush flora was proof.

On the bottom of the wall of the first garden hung a relief of some sort of plant, with D'ni words inscribed on some of its branches. Something about it compelled me to take a picture. I couldn't read the writing, so I decided to ask Catherine or Atrus about it when life calmed down a bit.

I climbed back up the ladder and proceeded through the first garden to the pathway that connected it to Catherine's study and the second garden. Yeessa appeared in the doorway of the second garden and called to me. Remembering Atrus's last words, I hurried over to her.

She pointed to a lizard on a railing of the second garden, which promptly scurried away. "Don't worry," she said. "He'll be back. It's his favorite sleeping spot." I smiled at her as she told me that she knew this because her necklace had told her. Indulging her, I listened as she said that



*I took a picture of the etching on the wall.*



*Yeessa called to me from the second garden.*

she found the necklace two weeks ago in an Age called Serenia. Yeesha said that her father didn't believe that the necklace told her anything. A chuckle died in my throat as she spoke her next words. "But my brothers believe me, though."

How had Yeesha spoken to Sirrus and Achenar? Before I could ask her, she skipped away.

### ***From Tiny Seeds, Great Deeds Are Sprung***

*Yeesha's eagerness to engage others—and elicit a caring response for all life forms from them—has long been recognizable to DRC members. This particular entry in the stranger's travel journal reflects it even as it shows how Yeesha's interest in living creatures was already well developed by age 10.*

*However, to be honest, some question does remain as to the exact interaction that took place in the gardens that day. Yeesha's own accounts say nothing about showing off her gecko, but instead focus almost exclusively on two things: her necklace and her beetle experiment.*



*Regardless, both versions of the tale provide ample evidence for what many now see as Yeesha's lifelong commitment to the study and preservation of all life, no matter what form it may take.*

### **Waterwheel Control Deck**

I proceeded through the second garden and stepped down onto the Y-shaped pathway that led to the waterwheel. Bearing right at the intersection, I soon arrived at the waterwheel.



*The path to the waterwheel*

Two lights flickered feebly on the waterwheel control deck. I pulled the lever in front of them, and they shut off completely. The massive waterwheel in the distance sat immobile. The torrent of water that would normally have set it spinning and producing electricity for Tomahna was being diverted away through alternate pipelines. I remembered Atrus telling me that I had to activate the sluice gates to restore power.



*Waterwheel control deck*

### Catherine's Study



*Catherine's study*

I backtracked along the wooden pathway to the second garden, then I walked back through the garden to see Yeesha standing in her mother's study, examining a glass jar. "Don't tell me," she snickered. "Dad blew the power out again, didn't he?" She said that, due to the frequency of these events, Catherine made Atrus install an emergency power generator in her study so that certain mechanisms would always have enough power.



*The emergency power was not being distributed properly.*

However, after Yeesha pointed out the power box to me, she gasped—the emergency power wasn't being distributed properly. Yeesha decided not to tinker with it, as her parents forbade her from handling electrical devices.

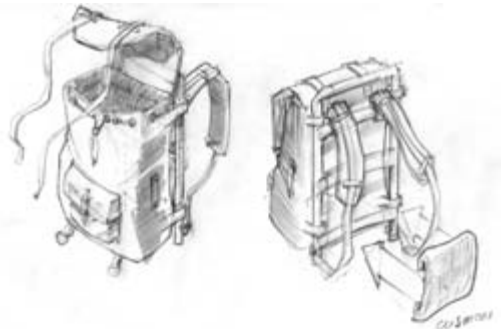



Yeesha turned her attention to a terrarium filled with insects and marveled that they seemed to be building a nest. She made a mental note to show Atrus when he returned, as "he loves that sort of stuff." With that, Yeesha skipped out of her mother's study. I didn't have time to concern myself with Yeesha's pet bugs or the many books that lay scattered around the study. I had to get the power working.

### ***Yeesha's Beetle Experiment***

*The phrase, "tell me what you see" is something of a mantra among DRC members. Here we see evidence that Yeesha knows the phrase too, for the beetle project she and her mother were conducting in Catherine's study appears to have been grounded in observation.*

*Unfortunately, we will never know what conclusions mother and daughter would have drawn from their project, as the experiment was somehow interrupted before they could finish. It's not clear that the disruption can be attributed to the stranger. But some of us have our suspicions.*



### **Restoring Waterwheel Power**

The emergency power controls apparently provided electricity to six different mechanisms, judging from the six columns of lights at the top of the controls (only two columns were lit). I recognized the symbol at the bottom of the right lighted column as one I saw near the controls for the elevator I rode from Atrus's laboratory. That explained why the elevator was one of the few devices that still had power in Tomahna.



*There were six rows of lights, only two of which were lit.*

After a bit of trial and error, I figured out the rest of the controls. The top row of six buttons below the columns of lights was the "transfer from" row, and the row of six buttons below them was the "transfer to" row. So for example, if I wanted to transfer power from column five to column three, I would press the fifth button from the left on the top row and the third button from the left on the bottom row.

Another button in the lower-right corner of the device actually transferred the power, and a lever in the lower-left corner reset the emergency power controls to their initial positions.

To restore power to a device, all of the lights except the top red light had to be lit in the column that corresponded to that device. The two middle columns (three and four) were marked with the design I'd seen on the waterwheel control deck, so it didn't take me long to figure out that I had to transfer the power to those columns. This is how I did it.

1. *Transferred column one to column six. Column one held more power than column six, so some yellow lights remained lit in column one.*
2. *Transferred remaining power from column one to column three.*
3. *Transferred column six to column five, reducing column six by one light and increasing column five by one light.*
4. *Transferred column five to column four, filling up column four (one light too many).*
5. *Transferred column four to column six, removing column four's single surplus light.*



*Emergency power redirected to the waterwheel*

As soon as columns three and four were lit with exactly five lights apiece, the waterwheel control deck icons under them began flashing, indicating that power had been restored to the waterwheel control deck.

### Activating Sluice Gates

With emergency power restored to the waterwheel control deck, I exited Catherine's study and turned right, walking through the second garden on my way to the Y-shaped pathway that led to the waterwheel control deck. The lights on the waterwheel controls were lit up, indicating that power had been restored.

I pressed the button on top of the waterwheel controls and activated the sluice gates, sending water cascading down the waterwheel, which began generating electricity again.



*Backtracked to the waterwheel control deck*



*Pressing the button on top of the controls activated the sluice gates.*

### **Understanding Tomahna's Complex Energy System**

*A great deal has been written about Atrus's pioneering use of natural resources. The waterwheel in Tomahna is a prime example.*

*When operating correctly, emergency sluice gates to either side of the wheel remained closed, while smaller gates directly above the wheel sent water cascading down. A generator to the left of the wheel produced energy, which was then carried via cables to a massive, underground "battery" installed beneath the gardens.*

*Evidence suggests that the emergency power box mounted in Catherine's study was an afterthought that had to be installed much later—once it became apparent that Atrus's experiments frequently overtaxed the system. This box was supposed to maintain a small reserve of power for short periods, should the waterwheel accidentally shut down. Items connected to the box were those whose inactive status might either place the family in danger (such as a nonfunctioning cable car) or be most disruptive to their daily activities.*



### CATASTROPHE



*I left the waterwheel control deck.*

With the power restored, I resolved to return to Atrus's laboratory and try to contact him in the Rime Age. I also wanted to keep an eye on Yeesha, especially after what she'd said about her brothers. I turned around and left the waterwheel control deck.

Yeesha crossed the pathway in front of me, heading away from the gardens and toward Atrus and Catherine's bedroom. As I moved to follow her, an explosion rocked the pathway, sending it—and me—tumbling to the ledge below. I don't remember hitting the ground, only waking up there several hours later.

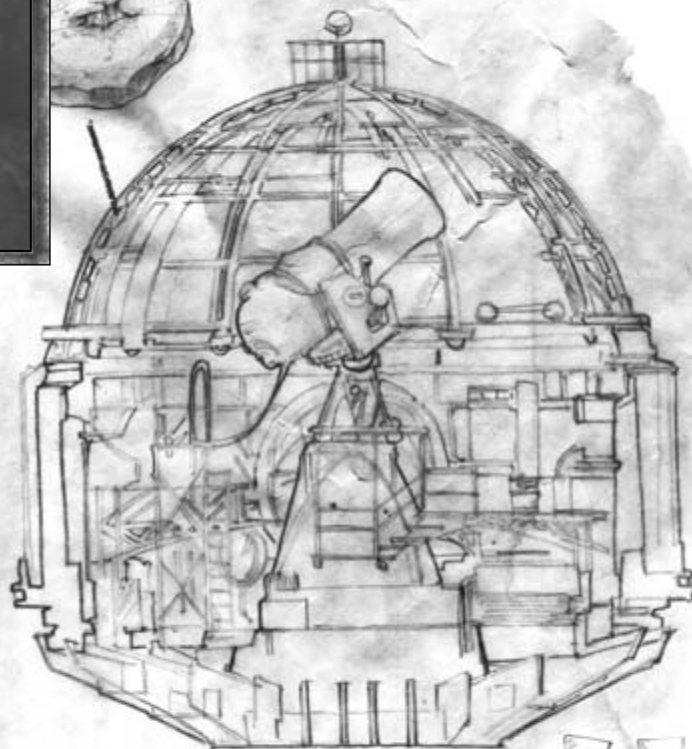

# Tomahna, Part Two

//

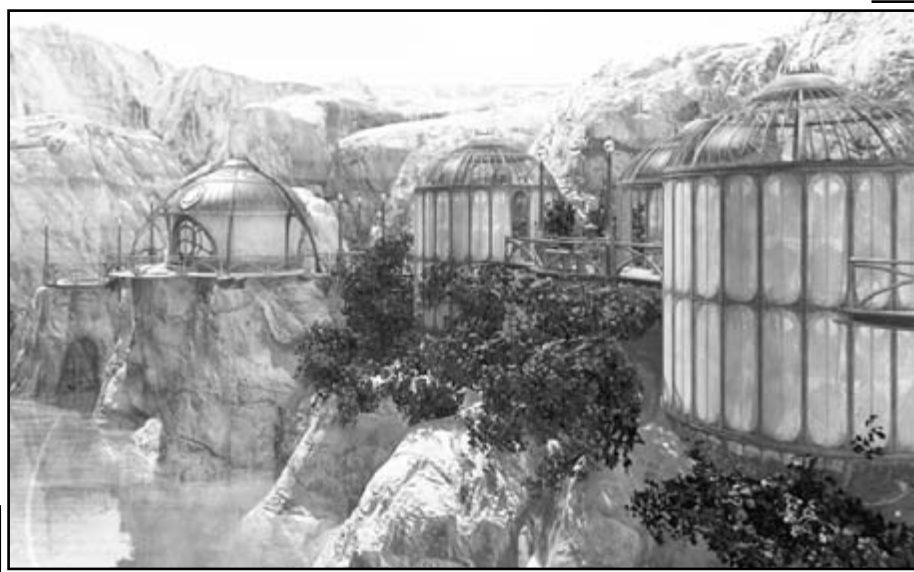

## RETURN TO ATRUS'S LAB

When I finally awoke, several hours had passed. It was now night, and for a moment I couldn't remember where I was or what I was doing there. As my blurred vision gradually cleared, so did the fog in my mind.

I winced as I gingerly touched the knot on the back of my head. What had happened? I remembered the walkway giving way under me. Was it some sort of natural occurrence that triggered it, an earthquake perhaps? I immediately discounted the idea. I couldn't imagine Atrus designing any structure for his family's living space that couldn't withstand a tremor or two.



*My vision was blurry for a short time after waking up.*

As I struggled to remember what had happened, I recalled the bright flash and thunderous sound beneath the walkway—an explosion then. But what could have caused it? I felt confident that it was nothing I had done. After all, I had followed to the letter Atrus and Yeesha’s instructions for restoring the power.

My blood froze in my veins. *Yeesha. Where was she?* I remembered seeing her crossing the pathway, heading toward her parents’ bedroom just before the blast. I had to find her, and quickly.

The explosion had destroyed the pathway, leaving me unable to reach Atrus and Catherine’s bedroom directly, but I was able to climb the ruined walkway behind me like a ladder to reach the second garden. I was relieved to see that Tomahna’s lights still glowed with electricity, as there was no way for me to return to the waterwheel with the wooden pathway shattered.



*I climbed the ruined pathway like a ladder.*

In a daze, I stumbled back through the second garden and the first garden beyond it to reach the elevator. I decided that my first priority was to contact Atrus in the Rime Age and alert him to what had happened in Tomahna. Stepping into the elevator, I raised the lever inside of it to send it up to Atrus’s laboratory.



*I backtracked to the elevator and rode up to Atrus’s laboratory.*

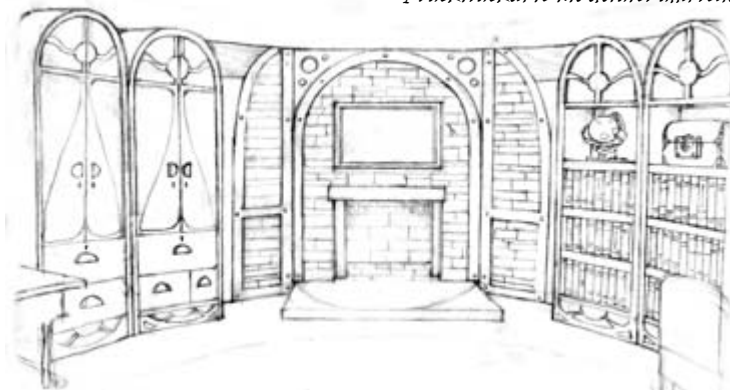

## Atrus's Journal

I remembered Atrus telling me that I could contact him on Rime by looking in his journal for the correct Crystal Viewer combination, then reactivating the Crystal Viewer by adjusting the antenna on the roof. Approaching Atrus's desk, I opened the drawer underneath his globe to find his journal.



*I found Atrus's journal in his desk.*

Atrus's journal alternated between details of his experiments with the Crystal Viewer and his private agony over how to deal with his sons. Toward the end of the journal, the two lines of thought merged into one as Atrus mentioned using the Crystal Viewer to see Sirrus and Achenar in their Prison Ages.



*The Rime combination for the Crystal Viewer*

## Reactivating the Crystal Viewer

Although the power was flowing freely to every other device in the laboratory, the Crystal Viewer was not operational. I looked around the room to see if I could discover how to reactivate it.



*The Crystal Viewer was not operational.*

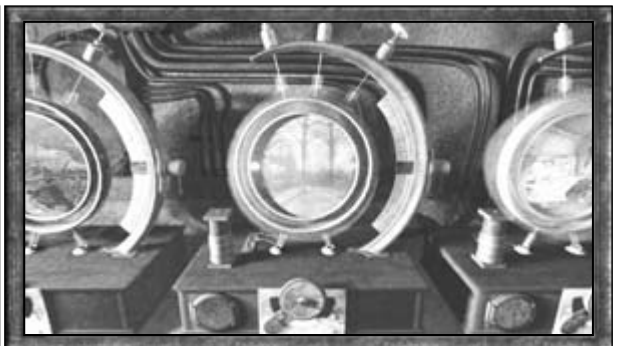

*Security monitors—what purpose could they serve?*

Walking past the Crystal Viewer, I saw three monitors shaped like portholes on the side of a ship. Examining them more closely, I saw that they displayed images of various areas on Tomahna. I supposed that after Saavedro's ambush years ago, Atrus constructed these to feel a bit more secure. But what if he suspected a different threat and was making quiet preparations to deal with it?

### *Atrus's Security Fixation*

*Atrus's obsession with security comes as no surprise to DRC members. Having lost so many of his Linking Books on Myst, then having his new home broken into 10 years later, he obviously had to do something.*

*The installation of security cameras in Tomahna roughly correlates with the period in which Atrus began improving his Crystal Viewer. This is significant, as it suggests that the technology used by his cameras may have been a precursor to what was used in the viewer's "movable eye" attachment.*

*Very little is known about this particular device, as Atrus abandoned work on it shortly after the Prison Age escape. Perhaps by studying the cameras' technology, we may someday re-engineer what Atrus left unfinished.*

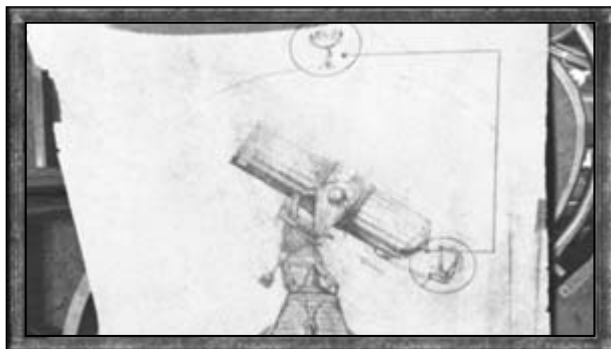
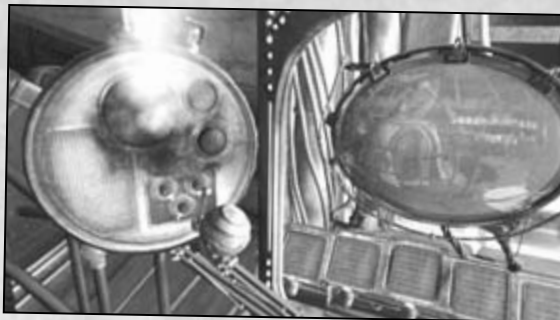

*A sketch behind the map—so the telescope activated the roof antenna.*

I turned to look at a map of Tomahna next to the monitors. Lifting up a corner of it, I saw a diagram that implied that the giant telescope that dominated the laboratory somehow activated the Crystal Viewer's roof antenna.

I pulled a switch on the railing near the monitors, and a large section of the roof slid open, revealing the night sky beyond it. The telescope looked out through it.



*A switch on the railing near the monitors opened the roof.*

### ***Focus on the Stars***

*Surprisingly, very little attention has been given to what must have been a key area of research for Atrus: astronomical observations. It's obvious the man spent a great deal of time studying the cosmos—why else would he have created not just one observatory, but two in his lifetime (the first one on Myst Island and the second, much larger one, in Tomahna)?*

*Sadly, many people only look at Atrus's astronomy notes when searching for insights on the father-child relationships that centered around it. Really, folks—if we ever do prove conclusively that Atrus spent less time engaging SIRRUS and Achenar in this hobby than he did with his daughter, have we actually learned something we didn't already know?*



*I sat in the telescope chair to reach the telescope.*

After opening the roof, I walked past the security monitors, sat down in the chair at the end of the pathway, and touched the blinking red button on the chair's arm. As soon as I did, the chair spun around and lifted me up to the telescope.

There were only three controls for the telescope. Dials on either side of it adjusted the view, and a button in the upper-right corner—which bore an icon that resembled the Crystal Viewer—glowed when I pressed it.

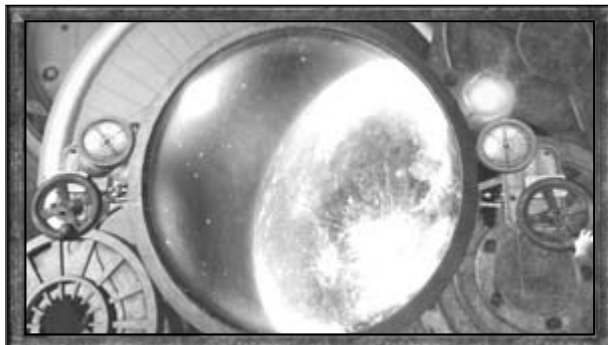

*Dials on either side of the telescope changed the view; the upper-right button activated the Crystal Viewer's roof antenna.*

I spun the chair to face the Crystal Viewer and saw that its formerly dark monitor now glowed with a shimmering display of static. The roof antenna was evidently now operational. Pressing the chair's red button again, I returned to floor level and approached the Crystal Viewer.



*The Crystal Viewer was operational.*

## Contacting Atrus

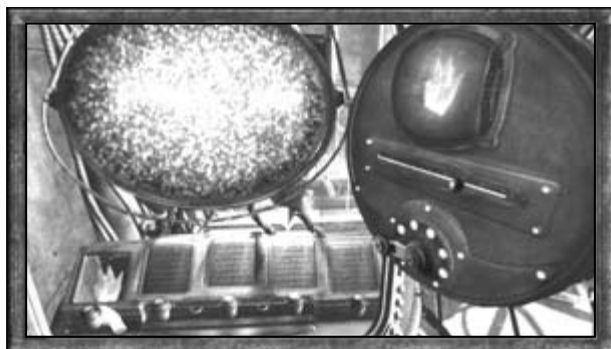

*Crystal Viewer controls: the horizontal slider chose the crystal shape while the lever below it determined the color.*

Now all that remained was for me to enter the correct combination of crystals into the Crystal Viewer so that I could contact Atrus on Rime. I knew from his journal that each crystal emitted a specific resonance, depending on its color and shape, and that combining the right series of five crystals would allow me to reach Rime.

There were eight different shapes of crystals to choose from, which I numbered one through eight according to their positions on the slider (one being leftmost, eight being rightmost). There were also six different colors for each crystal: red, yellow, green, blue, indigo, and purple. After choosing the shape and color for the crystal, I just had to touch the button below the slot where I wanted it to appear.



*Rime's crystal configuration: six-red, four-blue, eight-yellow, eight-green, two-indigo*

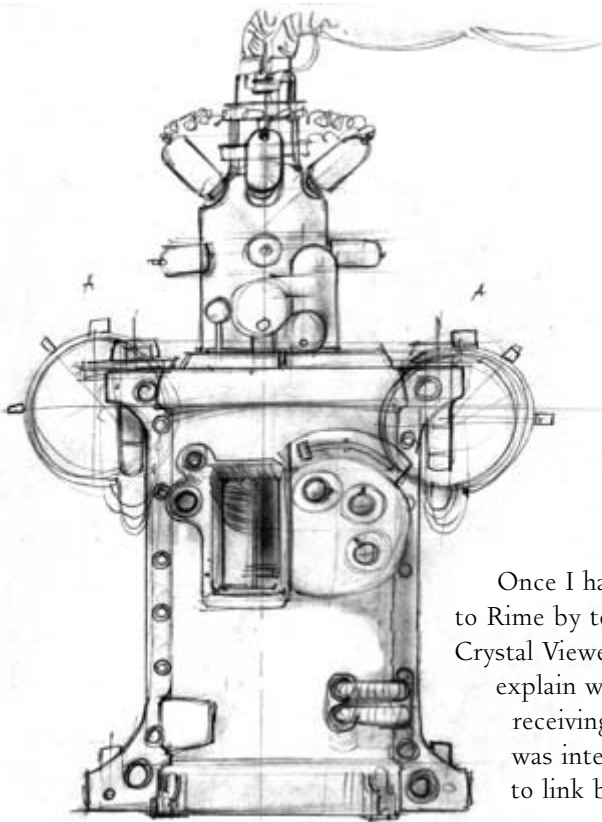

*I could barely hear Atrus, and he couldn't hear me at all.*

Once I had the correct five crystals, I activated the connection to Rime by touching the large red button at the bottom of the Crystal Viewer. Atrus's face appeared in a haze of static. I tried to explain what had happened on Tomahna, but he wasn't receiving me. He said that an electromagnetic storm on Rime was interfering with his equipment, and he wouldn't be able to link back to Tomahna until it was over.

He asked me to go to his bedroom, find a symbol just below the uppermost drawer of the desk, and press it to open a compartment containing his commentaries on Spire and Haven, his sons' Prison Ages. With an oblivious grin, he also told me to tell Yeesha to do her homework. My heart sank as his image faded.



### ATRUS AND CATHERINE'S BEDROOM

Atrus had specifically told me to look for the commentaries in his bedroom, and the last time I saw Yeesha, she was heading in that direction. I had to find an alternate path to reach it. From my previous visits to Tomahna, I recalled that riding the elevator all the way to the bottom level would take me along a rail to the entrance of Atrus and Catherine's bedroom. I wasted no time in riding the elevator all the way down and across the surface of the water.

When the elevator came to a stop, I exited and ascended the stairs in front of it to reach Atrus and Catherine's bedroom. Approaching the desk, I found the symbol that Atrus instructed me to press, but nothing happened.

While searching the desk, I opened the topmost drawer and found a sketch of some sort of device that was apparently installed in the fireplace. It required me to turn on both of the bedroom's lamps to activate it.

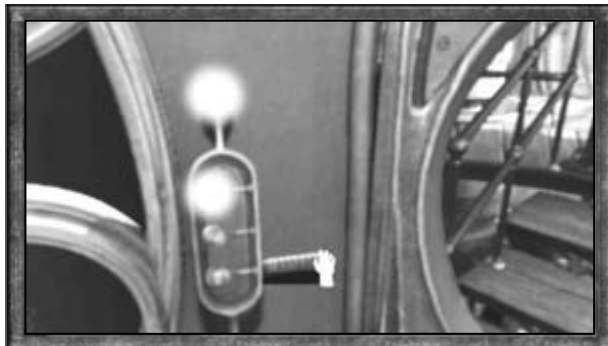

*I rode the elevator all the way down to water level.*

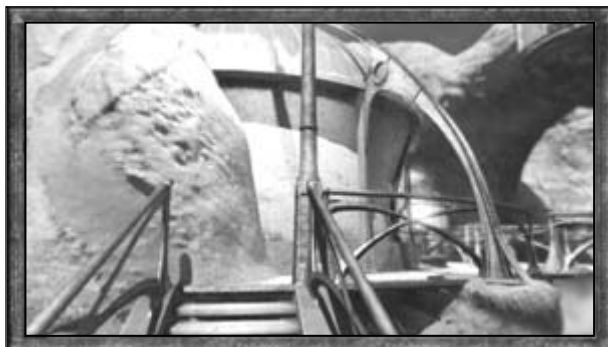

*The elevator came to a stop in front of stairs leading to Atrus and Catherine's bedroom.*

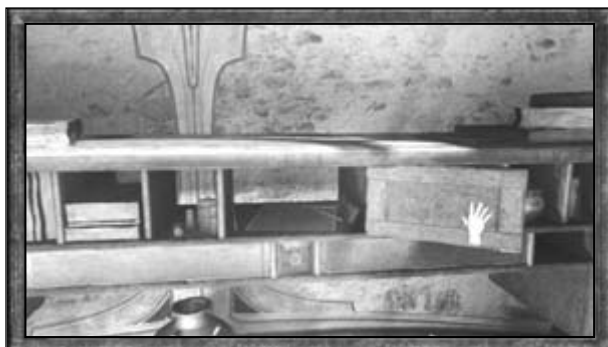

*I opened the desk drawer to find instructions for a device in the fireplace.*

## Commentary Books



*I could now press the symbol and open the hidden compartments.*

After opening that drawer, I could now press the symbol and open two hidden compartments near it, revealing a red book and a blue book. I could hear Atrus's sons' voices echoing in my mind from 20 years ago saying, "Bring me the red pages," and "I must have the blue pages."



*Spire commentary—contained Crystal Viewer settings.*



*Haven commentary—also contained Crystal Viewer code.*

The red book contained commentary on Spire, SIRRUS's Prison Age, and the blue book contained commentary on Achenar's Prison Age, Haven. I noted with some sadness that both commentaries were written before Atrus knew his sons' greed would lead them to imprison themselves in the Ages.

I made sure to photograph both commentary books' Crystal Viewer combinations for future reference, should I ever need to use them. I then resolved to see what this fireplace device was all about, turning on the lamps on the desk and nightstand as the instructions indicated.



*I turned on the desk lamp and nightstand lamp.*

As I turned on the nightstand lamp, I noted that only half of the bed remained unmade, a sure sign that Atrus and Catherine were fighting. A note on the opposite nightstand confirmed this.



*Atrus my love,*

*We must be united in this. Can you find it in your heart to listen and forgive? For I cannot be strong in this alone.*

*Catherine*

It was obvious that Atrus's struggle to determine the best course of action regarding his sons was complicated by a number of factors, including the feelings of their mother.

### Fireplace



*A portrait of the family in happier times*

Not wishing to intrude on Atrus and Catherine's personal life any more than I already had, I turned my attention back to the fireplace. A portrait hung above it, showing Atrus, Catherine, and their young sons enjoying an afternoon on Myst Island. It reflected the conflicted love of a parent—Atrus's condemnation of his sons' actions had done nothing to erase the paternal love he obviously still held for them.

### ***The Artist behind the Family Portrait***

*The family portrait believed to have been on display in Atrus and Catherine's bedroom has even more significance than researchers first realized. Evidence uncovered in the Cleft suggests this portrait may have been painted by Anna, Atrus's much beloved grandmother.*



*Apparently, Anna painted the image while she was living with the family on Myst Island. If so, the portrait certainly would have evoked bittersweet memories for everyone, as Anna's death is believed to have been one of the contributing factors in Sirrus and Achenar's moral decline.*



*Yeesha's necklace sat in the fireplace.*



*I saw an image of Yeesha being grabbed by an unknown person.*

As I approached the fireplace, I saw a blue object glittering in a corner of it, which I immediately recognized as Yeesha's necklace.

I scrambled into the fireplace and picked up the necklace. As I touched it, I saw a vision of Yeesha being pursued by someone who chased her into this room. Yeesha managed to slip into the fireplace and shut the grate before the interloper could reach her. But at that point, her necklace fell off, and the vision ended. My heart leapt into my throat. I couldn't afford to wait for Atrus to return—I had to find Yeesha immediately.

I turned around and examined the fireplace, pressing the button that I had seen Yeesha press in the vision. The fireplace grate slid down, revealing an eight by six grid of squares. Beams of light from the table lamp device illuminated several of the squares.

I quickly surmised that the beams of light represented the combination of squares that would solve this puzzle—and hopefully lead me to Yeesha. However, unlike the original fireplace puzzle on *Myst Island*, touching a square activated the four squares around it, not the touched square itself.

After some trial and error, I figured out that there were only seven squares that needed to be touched in order to activate all of the squares marked with beams of light (and only those squares).

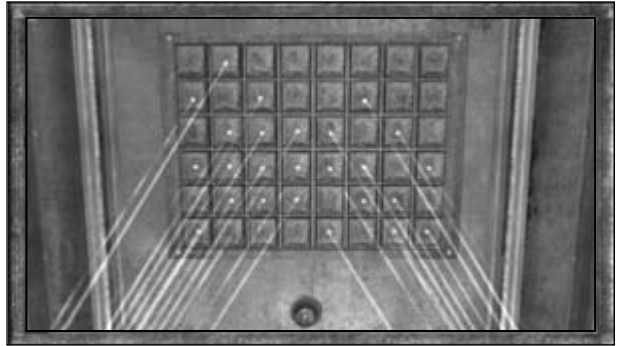
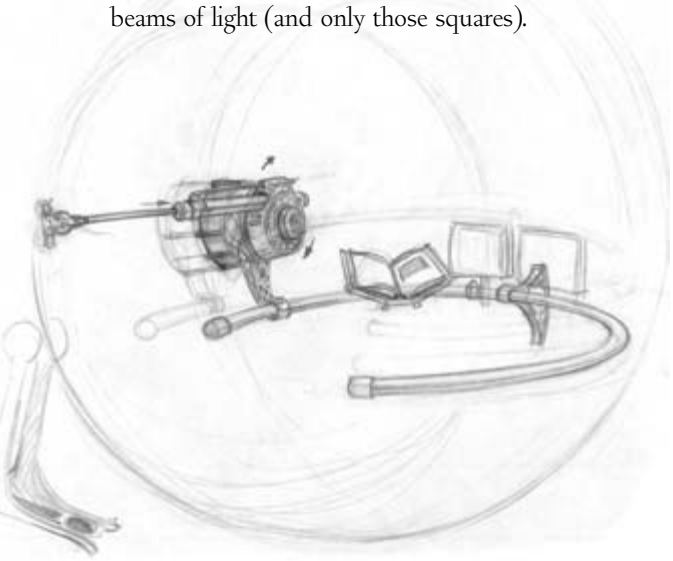

*I pressed a button, revealing a grid of boxes, like the *Myst Island* fireplace puzzle.*



*Touching a square activated the four squares around it, not the square itself.*

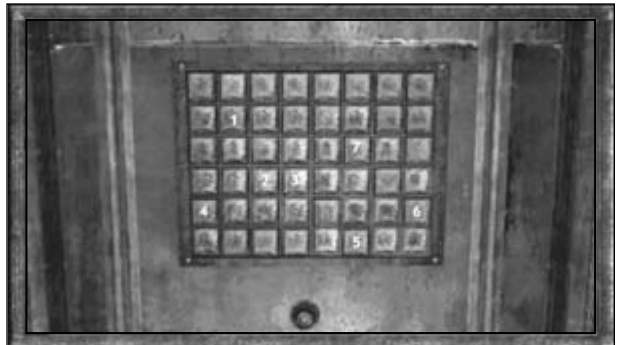

*The solution to the puzzle—I touched these seven squares.*

## HIDDEN LINKING CHAMBER

As soon as I entered the correct combination of squares, the floor of the fireplace dropped, taking me down to a hidden underground chamber. I stepped out of the fireplace elevator and examined the cavern.



*The fireplace became an elevator leading down to a hidden linking chamber.*



*Whatever caused the explosion originated here.*



*Two books—red and blue*

One thing was immediately obvious. The explosion that rocked Tomahna originated in this chamber. A huge iron door lay on its side, blown off of its hinges. As I approached the door, Yeesha's necklace began to glow. I touched the necklace and heard an echo of Atrus's voice telling Catherine that they would see their sons again soon. All that remained was for them to install this security door.

I turned to examine the golden pod at the end of the room, already starting to figure out what this room was used for. The two Linking Books—red and blue—inside the pod confirmed it. Atrus had designed this chamber for use when and if he and Catherine decided to release their sons from their imprisonment.

## Origins of Tomahna's Linking Chamber



*It's interesting to note that Atrus was not the first D'ni descendent to write a Prison Age. Nor was he the first to build a secure "linking chamber" to access such worlds. Journals written by Atrus's grandmother describe a similar chamber in use during the trial and imprisonment of Veovis, D'ni's most notorious villain.*

*No doubt, Atrus heard of such chambers through Anna and may have based Tomahna's underground linking room on her description. We can never be sure, however, since the most vivid description that exists of Tomahna's chamber comes from the stranger's report—and the stranger only encountered it after the room had been shattered in the escape attempt.*

With trembling hands, I pulled the lever outside of the pod and watched as it spun on its horizontal axis and opened, granting me access.

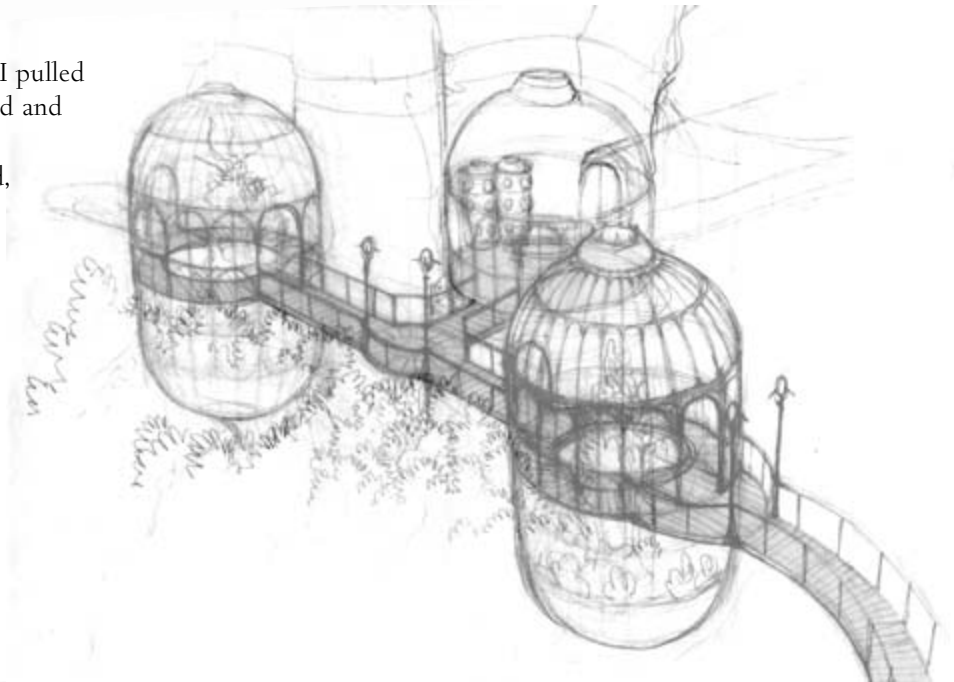

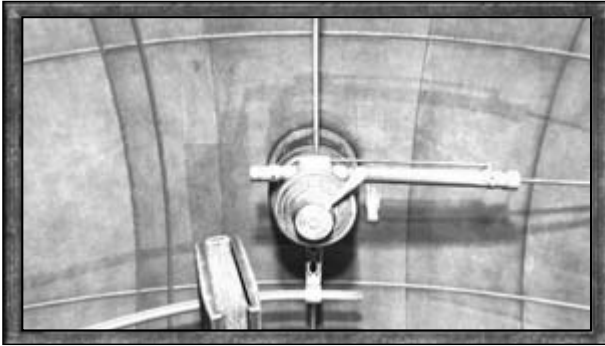

*A second lever in the pod closed the door and opened the books.*

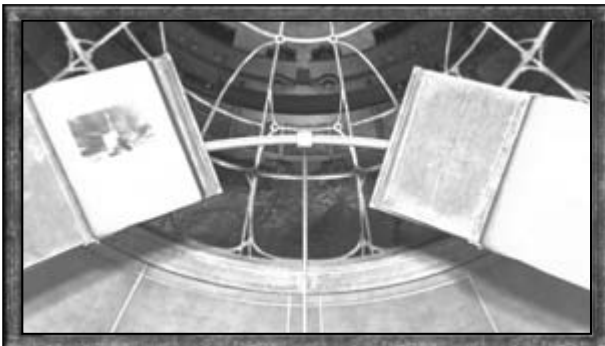

*I decided to begin my search for answers in Spire.*

But surely they wouldn't harm their own sister? There was no time to contemplate such things. I turned to my left and placed a hand over the Spire book's Linking Panel.

Atrus had added a second lever inside the pod as an additional security measure. Pulling it locked the pod and opened the Linking Books. The red book to my left showed an image of Spire in its Linking Panel while the blue book to the right seemed to lead to Haven.

All of this security, and it seemed as if none of it had stopped someone from linking to Tomahna, detonating a bomb of incredible power, and perhaps abducting Yeesha. The list of suspects was short—only two names long, in fact. The only thing that remained to be seen was if it was SIRRUS or Achenar who did this—or perhaps it was both of them working together.

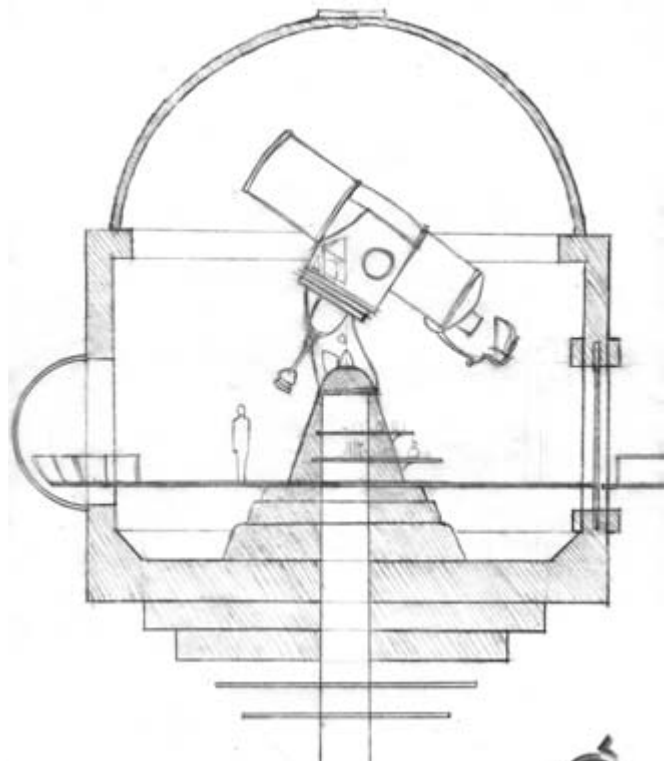



## Spire //

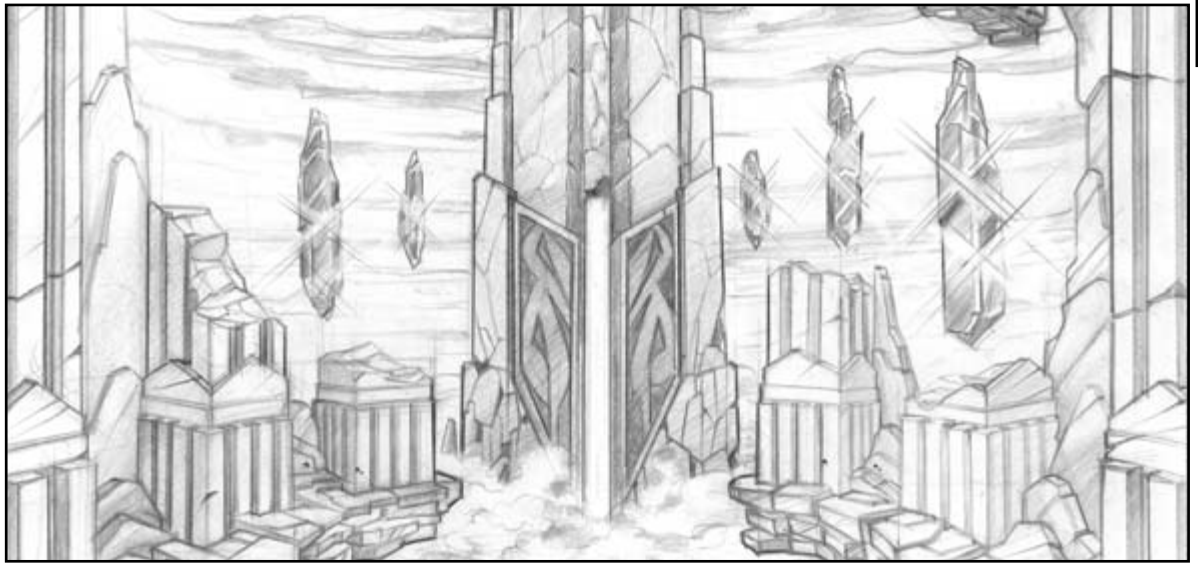

### FIRST ISLAND

When I first opened my eyes after linking into Spire, I gazed directly at a celestial body, either a bright moon or dim sun, which illuminated a bank of clouds below me.



*A sun? A moon?*



*Tomahna Linking Book*

I looked down to my right and saw a Tomahna Linking Book, which I could use to return to Tomahna at any time. I turned around and examined the rest of this linking chamber, which had been ripped apart like the one on Tomahna. However, where the Tomahna chamber seemed to have been blown apart from the inside, this one seemed to have been shattered by an outside force.

### ***The Art of Writing Linking Chambers***

*Spire's chamber may have been ripped apart in the same manner as the one in Tomahna was, but that is where their similarities end. Unlike Tomahna's chamber—which was built by stonemasons from Releeshahn—the chambers that the stranger discovered in both Prison Ages were written into existence. That is, Atrus added their descriptions to each Prison Age descriptive book long after the original link was established.*

*This, of course, contradicts much of what we've gleaned about the Art. Atrus's "Riven Journal" implies that only minor edits should be made to a book, lest one endanger its existing link. Yet certainly, a structure as detailed as these chambers can hardly qualify as "minor."*

*Knowing that the idea for the chambers originated with Catherine does offer some illumination. Catherine's Ages were legendary for defying D'ni Age-writing conventions (a talent she obviously passed on to her daughter). With Catherine and Atrus working together to make edits, their chance for success must have seemed guaranteed.*



The chamber had been divided in half by metal bars, now shattered. The half with the Tomahna book was isolated from the rest of SIRRUS's prison (obviously as some sort of visitor's room) while the other side held a D'ni schoolbook on a bench. Yeesha's necklace glowed as I brought it near. I touched the necklace and heard the echo of a conversation between Yeesha and SIRRUS, in which Yeesha offered to teach SIRRUS to read and write D'ni.

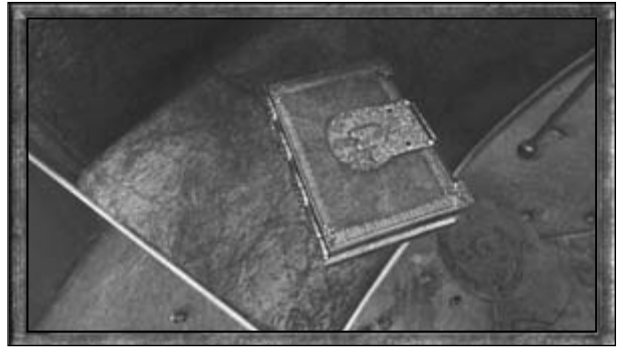

*This schoolbook stored a memory of a conversation between SIRRUS and Yeesha.*

Could SIRRUS have escaped from Spire by somehow detonating a bomb in this linking room and then using the Tomahna Linking Book? If so, it also seemed possible that he was the one who bombed Tomahna. I resolved to take a look around Spire and see if I could confirm any of this or find any trace of SIRRUS.

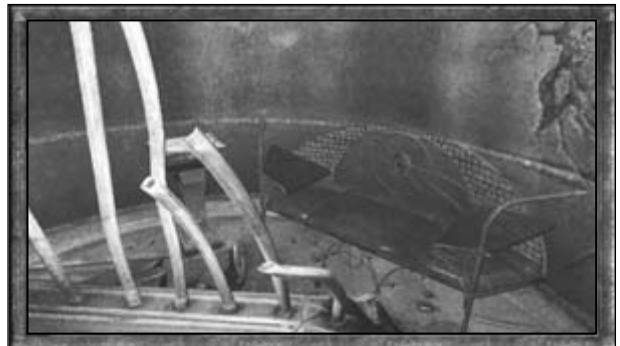

*The linking chamber was a wreck.*

I carefully headed down the narrow stairs that led from the linking room. As improbable as it seemed, according to ATRUS's commentary on the Age, these stairs were not man made but shaped naturally by the erosion of Spire's winds, the same winds that whipped past me now. ATRUS, with his scientist's mind, might have viewed Spire as a humane prison, but its stark landscape and bleak environment made me question my old friend's opinion of the Age.

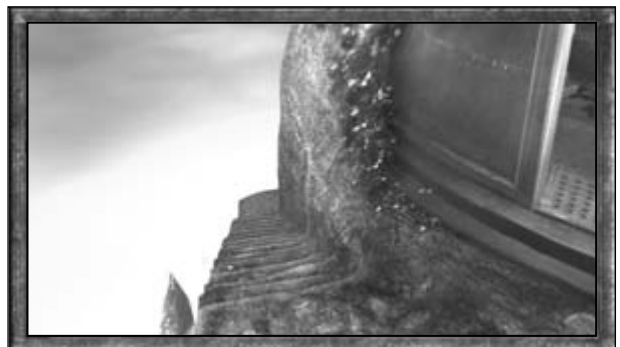

*I walked down the narrow stairs from the linking room.*



*A crystal replica of the fireplace painting*

At the foot of the stairs stood a crystalline reproduction of the Myst Island family scene I saw in Atrus and Catherine's bedroom. Yeesha's necklace glowed as I approached it, and when I touched the necklace, I heard SIRRUS talking to himself as he struggled to remember the scene. Obviously, he had carved this touching vignette. Was this an indication that SIRRUS had repented and wished to rejoin his family?

## **SIRRUS the Sculptor**

*DRC members most familiar with the lives of the brothers still debate exactly when SIRRUS's talent for sculpting first manifested itself. Had he experimented with it before the age of nine, he definitely would have benefited from his great-grandmother's instruction. Anna was an accomplished artist. No doubt, she would have encouraged the boy's ability had she seen signs of it.*

*Regardless of when it appeared, SIRRUS's talent most certainly came into its own during his imprisonment. Even today, Spire's chambers contain outstanding examples of his artistry—regardless of what one thinks of their subject matter.*

To the right of the statues were a burned-out fire, a bedroll, and some tools. Again Yeesha's necklace glowed, and touching it revealed a vision of SIRRUS, his blanket wrapped around him to ward off Spire's winds, desperately trying to discover a way out of Spire. Judging from his panicked expression, it seemed as if he had not yet grown used to his captivity.



*A vivid image of SIRRUS shortly after his imprisonment?*



*A "frequency crystal" with the fourth notch on the gauge marked with a white line*

Following a pathway to the left of the statues, I approached an enormous crystal (which I would eventually come to describe as a "frequency crystal" for reasons explained later). A gauge below it had the fourth notch marked with a white line. I photographed the crystal and its gauge, figuring that it was probably part of a larger mechanism.

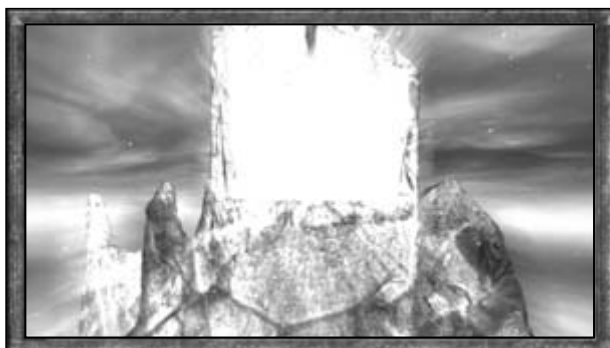

*A glimpse of the crystal's pentagonal base*

Touching Yeesha's necklace near the frequency crystal showed me a vision of its pentagonal base. I could not imagine at the time why such a trivial piece of information would be important, but I made a note of it anyway.



*A "windpipe" that led to the docking station*

To the right of the frequency crystal was a hollow stone tunnel that led straight down. The remnants of a frayed rope were tied to the opening. I touched Yeesha's necklace as I approached the "windpipe" (as I came to call it) and heard Sirrus talking to himself as he tied the rope to the tunnel's mouth. He hoped to find the Linking Book at the bottom of the windpipe.

As I examined the windpipe, I leaned too far over the edge and fell into it. My arms flailed wildly in a vain attempt to secure a handhold on the tunnel's smooth walls as I slid down.



*I leaned in too far and slid down the windpipe.*

## Docking Station



*Some sort of dock?*

My ride came to an abrupt but mercifully painless end in a lower level of the island. Looking to my left, I saw a string of what looked like illuminated buoys, floating below a sea of hovering boulders. The buoys were obviously man made, and an adjacent plateau gave the appearance of a dock.



*Sirrus referred to them as "conductors," meant to channel static electricity.*

I stepped onto the dock and looked out at the buoys. Yeesha's necklace emitted its signature tone, indicating that it had something to reveal. When I touched the necklace, I heard Sirrus shout triumphantly, obviously pleased that his "conductors" (as he called the buoys) were able to collect the static electricity in the atmosphere. He then set a goal for himself to channel the electricity for something more useful.



*A control panel of sorts—but for what?*



*Activating the seven conductors moved the "rock ship" all the way to the ground and stuck it there.*

Near the bottom of the windpipe, I found a control panel with a closed lid. As I examined it in detail, Yeesha's necklace allowed me to hear Sirrus talking about not wanting to "lose another ship." The sound of Sirrus activating an electromagnet and charging conductors could be heard in the background.

I opened the control panel lid by pressing the blue button to the left of it. A switch on the left side of the panel powered up the panel; I flipped the switch. A gauge on the right side of the panel appeared to display the height of some object, but what I didn't know. A sliding switch at the bottom of the control panel illuminated the seven crystals along the top of it.

After some trial and error, I realized that as I lit up more crystals, a "rock ship" above me descended farther. Wishing to examine the rock ship in greater detail, I illuminated all seven crystals, but the rock ship descended too far and stuck to an electromagnet below me.

**NOTE** TO ACTIVATE ALL SEVEN CRYSTALS, I FLIPPED THE POWER SWITCH FOR THE CONTROL PANEL AND MOVED THE SLIDER *RIGHT, LEFT, RIGHT, LEFT, RIGHT*.



The rock ship remained a mystery to me. I left it stuck to the electromagnet and decided to examine the rest of my surroundings. Between the dock and a ladder leading up to a trapdoor, I pulled a glowing green lever that revealed what I initially thought to be a second control panel.

However, an experimental touch resulted in a surprising shock.

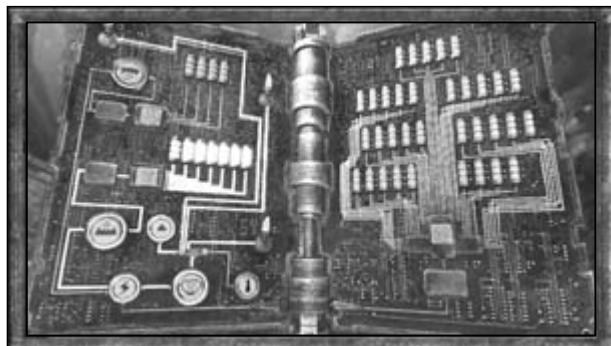

*Another control panel? Some sort of power diagram?*

On second glance, I decided that it looked more like a diagram of the power in the immediate area (since I had just lit up seven crystals at the nearby control panel, and now seven circuits were lit up on this device). Touching Yeesha's necklace confirmed that I was looking at a circuit network that Sirrus had amazingly built from scratch. A row of four dimmed circuits above the seven lit ones implied that there might be another control panel elsewhere, likely above my current position.

In my search for the second control panel, I turned around and climbed the ladder near the circuit network diagram. Unlocking the trapdoor at the top of the ladder, I pulled myself up into a dimly lit garden.



*I climbed the ladder leading to a trapdoor.*

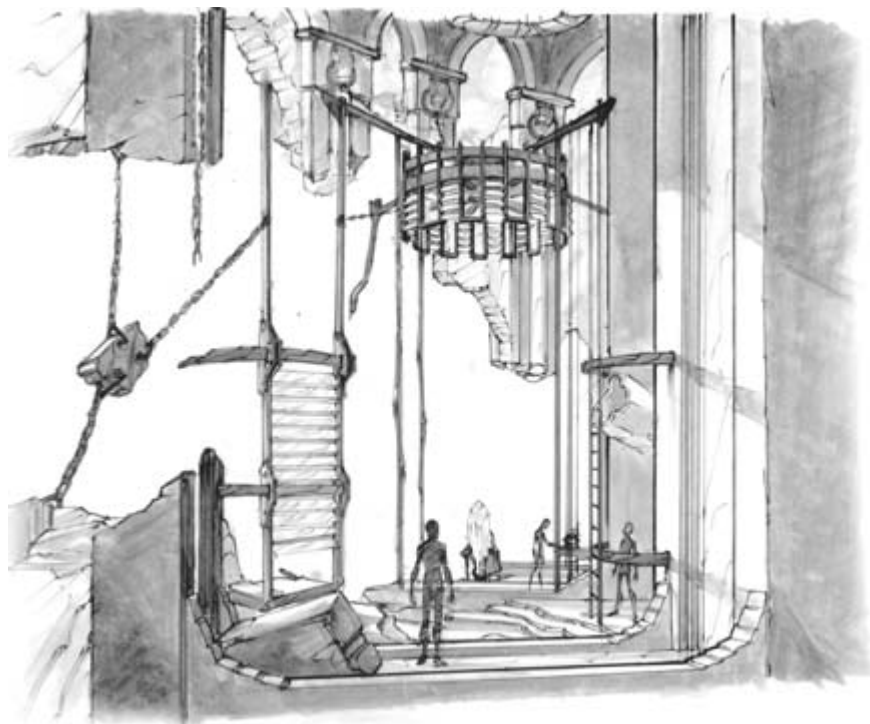



### Garden

The first thing that caught my eye in the garden was a nearby floating boulder, held to the docking station below me by a solid iron chain. Touching Yeesha's necklace as I examined the boulder showed me that Sirrus was as shocked by the boulder's impossible physical properties as I was. Sirrus was also determined to figure out a way to use the Age's floating rocks to free himself from his prison. I realized that the "rock ship" I had seen earlier must have been carved out of one of these boulders—perhaps this was to be the hull of Sirrus's next ship, had he lost his original one.



*A large, floating boulder was chained to the floor below me.*

I ignored the second ladder leading up and instead walked past the floating boulder, where I found one of Sirrus's journals on a rough-hewn stone desk. I took a moment to read it and found that it contained Sirrus's initial observations on Spire. His overriding goal was to find a Myst Linking Book that he was sure Atrus must have dropped into the clouds below as he linked away from Spire.



*Sirrus's journal was full of observations about the floating rocks and electrically charged crystals.*

Sirrus noted that the crystals of Spire naturally built up static charges that caused them to glow. When the crystals were discharged (by grounding them), they emitted a powerful shock and dimmed until they naturally absorbed more static electricity. They also produced a musical tone, which Sirrus hoped to incorporate into an amusing diversion in order to keep his sanity.

Sirrus saw flickering lights on Spire's other unreachable islands and considered that they might be evidence of other living beings—or simply more crystals. He came up with the idea of harnessing Spire's levitating boulders to fashion some sort of vessel that he could use to explore Spire more thoroughly. But to do that, he would have to find a way to keep the rocks from floating too high.

The crystals were the key to his plan. He deduced that the boulders were able to float due to some sort of diamagnetic property of the green minerals that ran through them. SIRRUS theorized that if he could attach crystals to floating rocks (the conductors I saw from the docking station), he could create an electromagnetic "rail" that would pull his "rock ship" to the next island.

Next to the journal was a small experiment in harnessing a crystal's electricity to control the levitation of a hovering rock. Touching Yeesha's necklace allowed me to hear SIRRUS's observation that as long as the crystal remained grounded, electricity passed straight through it.

I pushed the slider in the center of the experiment to the right and turned the crank at the base of the crystal, which caused the crystal to crackle with electricity. I then moved the slider to the left, and the electricity transferred to the floating rock, pulling it down for the duration of the charge.

So SIRRUS's science was solid—but could it actually be applied? It seemed that SIRRUS had a working model at the docking station, but I had yet to operate it for myself. I felt that it was essential to retrace his steps if I was to have any hope of discovering what had happened to him—and perhaps to Yeesha.



*An experiment with floating rocks and static electricity crystals*



*A telescope was pointed at the nearest island.*

To the right of the experiment was a crude telescope trained on the top of the nearest island. I looked through it, touching Yeesha's necklace as I did, and heard SIRRUS's desperate hope that reaching the near island would allow him to reach the ground and find his father's Linking Book.

Walking behind and to the left of the desk, I found a crystalline statue of Catherine holding a plant. Touching Yeesha's necklace revealed that Catherine had given Sirrus some of the plants that grew in her garden. This explained why several of the plants I saw growing in Sirrus's garden looked so similar to Tomahna's flora.



*A sculpture of Catherine—the source of the garden's plants*

### **A Scientific Approach to Gardening**

*Not everyone can grow a perfect garden, but judging by the plant samples collected from Spire, Sirrus most certainly tried.*

*The fact that he cross-pollinated plants is not that surprising. We know from Narayani records that both Sirrus and Achenar were quick to master many of that culture's advanced horticultural techniques. No doubt, Sirrus would have used what he learned on Narayan, if he'd believed it could improve the plant varieties in Spire.*



*What is surprising, however, is the extent to which Spire's flora has been genetically reengineered. Today, almost 20 percent of the samples taken from the Prison Age bear striking similarities to plants found on other Ages. We know that Catherine was in the habit of exchanging seeds with Sirrus. Even so, it's a startling result in less than 200 years of evolution.*

A table near the statue was littered with syringes, vials, and a large crystal full of green liquid. Something about them struck me as sinister. Perhaps I was being overly suspicious, but it didn't seem as if Sirrus was conducting simple horticultural experiments here. Or if he was, the experiments weren't just the result of Sirrus's desire to acquire a green thumb. Was this just an attempt to sway his mother to take his side over Atrus's?

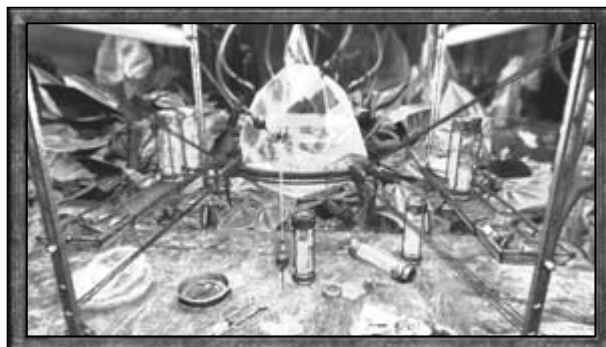

*What was this used for? Certainly not gardening.*

## Laboratory



*I returned to the ladders and explored the laboratory on the other side.*



*A page of Sirrus's notes near a ruined pillar—what could "8-12-4" mean?*

Having seen all that the garden had to offer me at the moment, I retraced my steps back to the ladder I had climbed and walked past it toward Sirrus's laboratory. The laboratory was a wreck—with rocks, boulders, and odd pieces of machinery scattered everywhere.

As I passed a broken pillar near the ladder leading up from the docking station, I happened to look down and see a page of Sirrus's notes. His conclusion, according to this note, was that he had to have "six lightning conductors charging cable #1 to disrupt sample's molecular constitution, provided other cables are set correctly." The combination "8-12-4" was marked with a check at the bottom of a column of other combinations with X's next to them.



*Sirrus's personal living space*

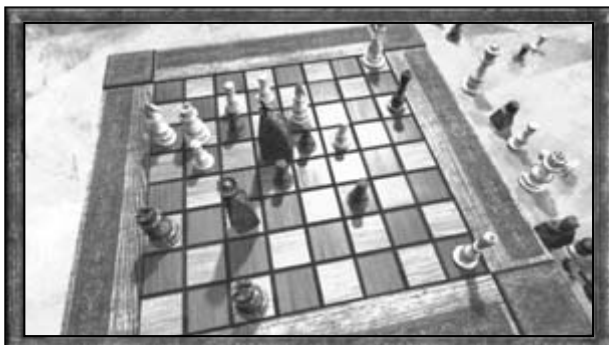

*Sirrus was playing against Atrus with chess pieces made of nara stone.*



*Another page of notes near Sirrus's washbasin*

I walked forward into the laboratory and saw Sirrus's bed and washbasin ahead of me to the left. A chess set sat on a table next to the bed; the pieces were arranged as if Sirrus was in the middle of a game with someone.

Yeessa's necklace revealed that Atrus was his opponent, and that Atrus had deliberately refused to put Sirrus into check, choosing to leave his own queen vulnerable instead. Sirrus remarked that getting Atrus to give him the chess pieces—which were made of *nara*, the incredibly dense D'ni stone—was more of a challenge than beating him at the game.

I found another page of Sirrus's notes next to his washbasin. Entitled "Blue Crystal Test #17," it verified that three lightning conductors were needed to power "cable #1" and disrupt the molecular composition of the sample. Sirrus noted that he was still testing to find "2 remaining increments."

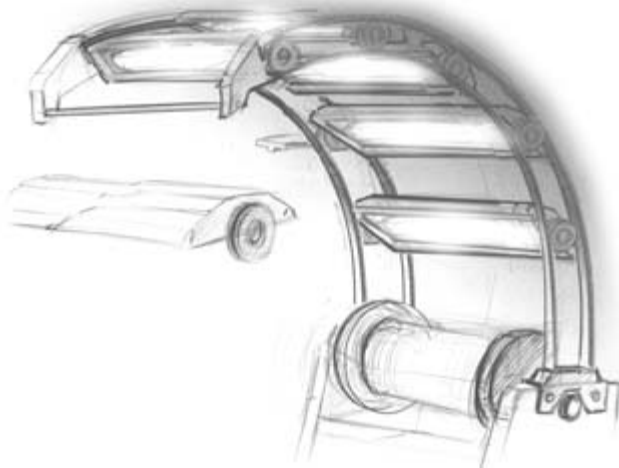

On the opposite side of the laboratory was another windpipe leading down. SIRRUS had constructed another desk next to it. Amid vials of green liquid and a variety of crystals, I saw two more sheets of notes.



*Another windpipe next to SIRRUS's desk*

The first showed a sketch of one of the *nara* chess pieces, with the note that it was stronger than any other substance—"will need all the power keyboard can take. Will even that be enough? If distributed... across all 3." This was accompanied by a sketch of a conductor control device lined with thirty-six buttons or knobs, with three nodes attached to it. Several three-number combinations were crossed out in the upper-right corner. I conjectured that the "8-12-4" combination I found earlier was the key to this device somehow.



*So SIRRUS wanted nara for more than just a game of chess.*

A second page of notes featured what looked like another sketch of the conductor control panel with the thirty-six buttons and three nodes. SIRRUS noted that every partially successful rock test suggested that he needed 20 units of power total, no more and no less. The trick was finding the combination in which it should be divided across three cables. I reconsidered my previous hypothesis, as the "8-12-4" combination added up to 24, not 20.

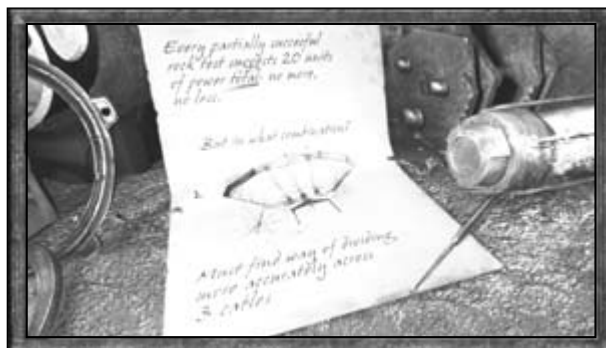

*Second page of notes—looking for twenty units of power total across three cables*

I opened a small compartment in the desk and found two more pages of notes. The top one showed a sketch of a blue crystal, with the following notes: "Blue crystal test results conclusive. Need to supply keyboard with total electricity gathered in garden and docking station only to disrupt these samples."



*Two more pages of notes in a compartment in the desk*

The second page of notes, found under the first page, read: "Strong earthquake-like tremors in lab when 2 of harmonics listed in musical chart were played. Could I be close to finding usable frequency? Lab mostly rock." It also had a sketch of a rock pillar, similar to the crumbled ones at the entrance to the laboratory. Had Sirrus accidentally stumbled onto some sort of frequency that destroyed his laboratory?

### ***The Explosion that Nearly Killed Sirrus***

*Recently, DRC researchers have assembled a fairly plausible timeline covering Sirrus's 20-year exploration and transformation of Spire's caverns. The timeline shows, for instance, that Sirrus must have set up his experimental lab within his first six months of imprisonment. (For it was here that he conducted most of his research into the electrical storage capacity of Spire's crystals.)*

*What the timeline lacks, however, are exact details as to when and how this first lab was destroyed. The only clues pertaining to that incident consist of an obscure entry in Sirrus's second journal and the following note, captured by the stranger's hand:*



*Was Sirrus still using this lab when he stumbled upon his greatest discovery? Or had he already relocated the bulk of his work to a second, much bigger cavern?*

*Information pertaining to Sirrus's activities in the five years immediately preceding the linking chamber's appearance becomes sketchy—if not downright nonexistent. So for the time being, it seems, our timeline must remain incomplete.*

At the end of the laboratory, perched next to a sheer drop into the clouds below, was another frequency crystal like the one I saw near the first windpipe I traveled through earlier. When I approached this one and touched Yeesha's necklace, I heard Sirrus announce the commencement of "rock test number twenty-nine... yes, this should be it. This should be the one." This was followed by the sound of a tremendous explosion. In the vision, I noted that the crystal had a hexagonal base. Its gauge—which I found had been blown across the room and embedded in Sirrus's bedpost—had a white mark next to the seventh notch from the top.

With the laboratory fully explored, I decided to slide down the windpipe next to the desk and see where it led.



*Another "frequency crystal" with a hexagonal base*

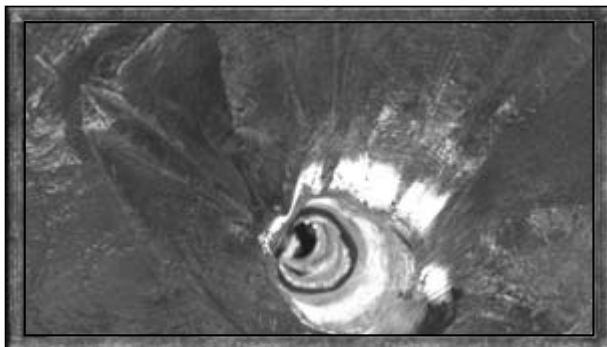

*I slid down the laboratory windpipe.*

## Prison Cell



*It deposited me in a prison cell.*

After a much shorter ride than in the first windpipe, I landed in what appeared to be a small prison cell. A large throne loomed in front of me. I approached it and sat down.



I pressed a blue button on the right arm of the throne, and two spidery arms on either side of it lowered a control panel into position. Noting the 36 buttons along the edge of it, I recognized it as the conductor control panel from SIRRUS's sketches. The control panel was completely unresponsive, so I touched the blue button again to retract it.

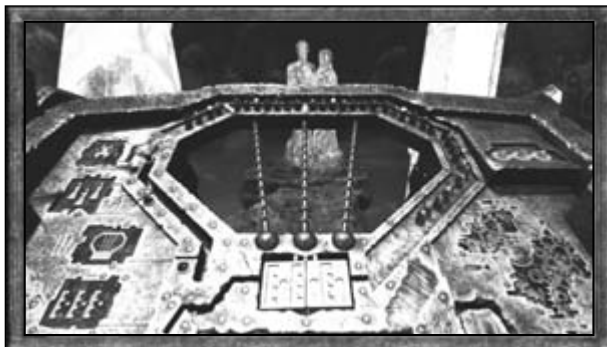

*The 36 buttons lining this device made it recognizable as the one from SIRRUS's notes.*

From the throne, I faced yet another crystal statue, this one of ATRUS and CATHERINE. I approached it and noticed that Catherine was holding a page of notes in her hand. Examining it more closely, I saw that it had a series of three-digit combinations on it.



*Another crystal statue, this one of ATRUS and CATHERINE*



### Three-Digit Combinations

First Digit	Second Digit	Third Digit
1	0	0
1	0	1
1	1	1
1	1	6
10	1	6
10	6	6
10	10	6
10	10	4
10	10	5
10	10	5
1	10	5

I had no idea what the numbers meant though I figured that they must somehow relate to the three nodes on the conductor control panel. I took a picture of the sheet for future reference.

Next to the throne was what seemed to be a power switch. One cable connected it to the throne, and two more snaked beyond a closed grated prison door. Hoping to restore power to the conductor control panel, I attempted to flip the switch but only received a nasty shock for my troubles.

I decided to see if I could follow the pair of cables leading out through the cell door. A quick pull on the lever next to the door opened it. After I stepped through the cell door, it closed behind me, leaving the stairs ahead of me as my only available avenue.

The electric cables stretched up and away from me as the stairs ended at an elevator shaft. (I later found that the cables led to the two control panels for the rock ship.) I chanced to look down and saw another page of Sirrus's notes. This page again seemed to confirm the "8-12-4" combination and contained the following remarks: "Quartz samples visibly affected when cables 1, 2 set correctly and 3 is powered by less than 5 conductors. Must be nearing point of total molecular disruption. Will conduct 1 final test to be sure."



*I got a nasty shock from this switch.*



*I pulled the lever to open the door.*



*The passage ended at an elevator, with a page of notes on the floor.*

I stepped onto the elevator platform and pushed its lever up. The machine creaked into action and deposited me at the garden/laboratory level. The only place left to explore was the one where the as-yet-unclimbed ladder between the garden and laboratory led.



*The elevator took me up to the garden again.*

**NOTE** I ALSO FOUND THAT, FROM THE GARDEN/LABORATORY LEVEL, I COULD RIDE THE ELEVATOR UP EVEN FARTHER TO REACH THE UPPER AREA OF SPIRE NEAR MY ORIGINAL LINKING POINT. THE PRISON CELL LEVEL WAS THE ELEVATOR'S LOWEST LEVEL.



## Riding the Rock Ship

I returned to the ladder between the garden and laboratory and climbed it to find another control panel with a sealed lid, just like the one I had seen at the docking station. Before I pressed the blue button to the left of it that opened its lid, I examined the markings on the lid in greater detail. Touching Yeesha's necklace as I did allowed me to hear the echo of Sirrus berating himself for his inability to find the proper balance of forces that would get the rock ship out of its dock.



*I climbed the ladder leading up from the center of the garden/laboratory level to reach a second rock ship control panel.*



*This panel raised the rock ship up enough to lift it off of the bottom electromagnet.*

Getting the rock ship to the docking station involved a bit of trial and error, and my labors are presented here in simplified form for the benefit of my readers.

First, I started with the rock ship stuck to the bottom electromagnet, the one at the docking station. (I did this

earlier in my journey by moving the docking station control panel's slider *right, left, right, left, right.*) Next, I illuminated two of the upper control panel's crystals by moving its slider *left, right, right.*

**NOTE** TO AVOID CONFUSION, I MUST STRESS THAT SIRRUS WAS WORKING ON MORE THAN ONE PROJECT IN HIS LABORATORY, AND MOST OF THE NOTES I FOUND WERE NOT APPLICABLE TO ACTIVATING THE ROCK SHIP.



I climbed back down both ladders to return to the docking station and saw that not only was the rock ship at the perfect altitude to ride the crystal conductor "rail" that SIRRUS had run to the nearest island, but a gantry had also been extended to provide easy access to the rock ship.



*I returned to the rock ship with the gantry now extended.*

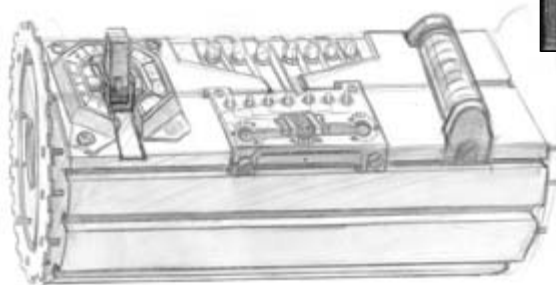

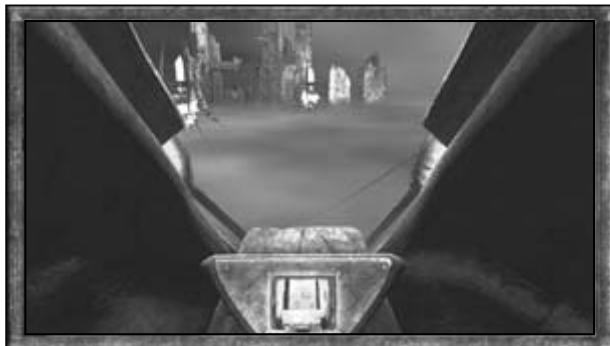

*I rode the rock ship to the nearest island.*

I wasted no time in climbing into the rock ship and throwing the throttle switch. The impossible craft lurched into motion and followed the path that SIRRUS had designed. I found I was too busy marveling at SIRRUS's obvious brilliance to fear for my life as I probably should have. I felt a profound sense of regret that his great mind should be wasted by his poor moral character, but this soon gave way to concern for ATRUS, CATHERINE, and YEESSHA. If SIRRUS could design something like this from scratch, what could he achieve if he ever did break free of this Prison Age?

## SECOND ISLAND

Upon arriving at the second island, I climbed out of the rock ship and followed the crude pathway from the dock. I saw a third control panel, similar to the ones I'd used to activate the rock ship, but it was on the other side of a large gap in the island.

The path ended at a shaft leading farther down into the island. Beyond that, I could see a third island in the distance. I touched Yeesha's necklace as I examined the shaft and saw SIRRUS descending into it with the assistance of a knotted rope. "At last," he exclaimed. "After all these years—freedom." I decided to follow his path.

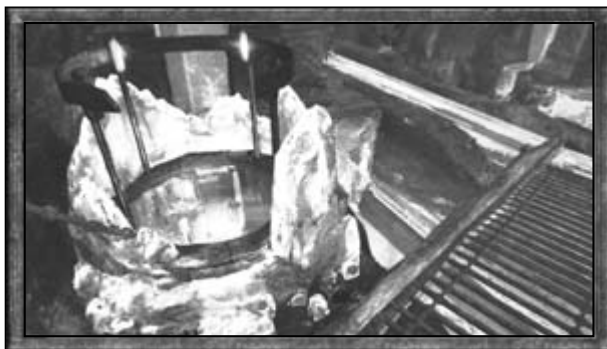

*I descended into a shaft from the top of the second island.*

Upon reaching the bottom of the rope, I got my first glimpse of what lay beneath Spire's layer of clouds. The islands did not protrude up from Spire's surface but rather floated hundreds—if not thousands—of feet above a glowing green celestial body, possibly a comet. Spire's floating islands were held in position by the gravitational pull of the comet below them and the moon above them. My present position was so far above the comet that I could actually see the curvature of it beneath me. Steeling myself against a wave of vertigo, I forced myself to stop looking down and noticed a nearby telescope aimed at the base of the first island, which protruded out from underneath the clouds.

Approaching the telescope, I touched Yeessa's necklace and saw a vision of Sirrus's reaction upon descending the rope and seeing how the object of his quest would never be found. Atrus's Myst Linking Book was gone, lost to the inky void of space. Through a supreme effort of will, he held his sanity together and vowed not to be defeated by his father's Prison Age.

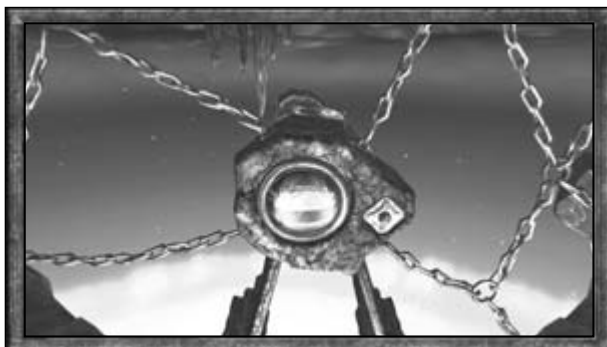

*A telescope at the bottom of the shaft*



*Sirrus was as shocked by the view as I was.*



### *Descent into Madness*

*Many DRC members question exactly how SIRRUS would have reacted the day he discovered the truth about Spire's floating islands. The journal he'd been keeping until then clearly shows faith in his own intelligence, as well as in his chances for escape.*

*Psychologists often point to that journal as clear evidence of SIRRUS's extreme delusional psychosis. For 10 years, they say, the man steadfastly refused to acknowledge his situation, viewing it as an inconvenience that he would alleviate the moment he reached ATRUS's dropped Linking Book. SIRRUS's need to find that book bordered on an obsession and may have been the only thing sustaining him through all those years.*

*When faced with the reality of Spire, and the depths to which his delusion had forced him to go, how did SIRRUS react? We'll never know for certain because his journal-writing efforts didn't resume until after the linking chamber appeared. Many believe, however, that SIRRUS spent those lost five years in a mad frenzy of destruction—expanding his rock ship network far beyond the second island and destroying all of the beauty to which his father's descriptive book had taken him.*

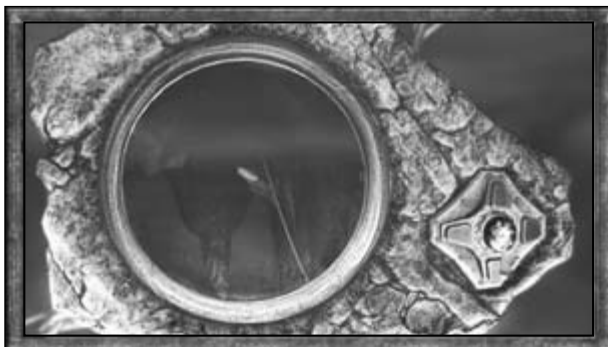

*I saw the third frequency crystal at the base of the first island.*

I looked through the telescope and manipulated the simple controls to the right of the imager to view the base of the first island in greater detail. A blue button in the center of the controls lit up when I was able to zoom in on an area of the island. I found a third frequency crystal in the upper-left corner of the telescope's field of view. Its gauge had a white mark three notches from the top, and its base had a circular shape to it.



*A massive gear with a floating boulder chained to it*

The only other part of the second island's base that I could safely reach was a narrow pathway that led to an enormous gear with a giant floating boulder chained to it. I pulled a lever at the base of the gear, but nothing happened. It appeared to be stuck.



*I pushed a small rock out of the way of the gear and pulled the lever again.*

I noticed a small rock between the teeth of the gear on its right side. I nudged the rock, which floated free, and pulled the lever again. This time, the gear turned freely, allowing the boulder to rise to the length of the chain.

I had an idea of what the boulder's purpose might be and climbed back up the rope to test my hypothesis, which proved to be correct. The boulder was now a stepping stone that allowed me to reach the third control panel, which overlooked 34 floating conductor crystals. Sirrus needed a great deal of power for something—but for what?



*The boulder acted as a stepping stone to the control panel.*

I sat down and considered which of Spire's puzzles remained unsolved. The only one I could think of was the conductor control panel on the throne in the prison cell. I remembered that it had 36 buttons around its perimeter—was this a clue to the number of energy conductors it would take to activate the panel?



Acting on my hunch, I manipulated the slider on the third control panel so that all 34 crystals lit up on the board. To do this, I flipped the activation switch on the left side of it and moved the slider *right, right, left, right, left*. The glow emitted by the 34 floating conductor crystals dimmed as their corresponding crystals were illuminated on the control panel, confirming that I had successfully transferred the conductor crystals' energy.



*I activated all 34 crystals on the third control panel.*

**NOTE** I FEARED THAT ENGAGING THESE ADDITIONAL CIRCUITS MIGHT RENDER THE ROCK SHIP INOPERABLE. BUT I FOUND THAT, UNLIKE THE TWO CONTROL PANELS ON THE FIRST ISLAND, THIS THIRD CONTROL PANEL WAS NOT WIRED INTO THE ROCK SHIP'S ELECTROMAGNETIC SYSTEM AND THUS HAD NO EFFECT ON THE ROCK SHIP.

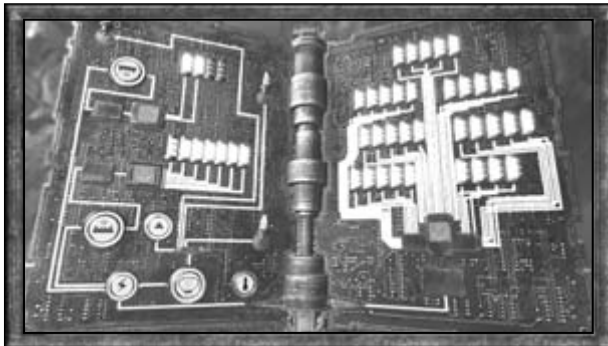

*The nearby circuit diagram showed a total of 43 circuits lit up.*

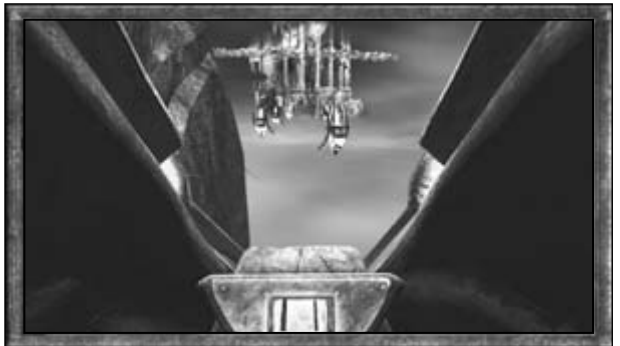

*I rode the rock ship back to the first island.*

Stepping back across the floating boulder, I managed to reach another circuit diagram device, similar to the one at the docking station on the first island. It showed a grand total of 43 active circuits.

Touching Yeesha's necklace proved that I was on the right track. Sirrus mused that once the circuits were activated, they would send power to where he needed it the most—to the throne in the prison cell. The vision ended with a disturbing comment that I did not understand until later: "Can you hear the music yet, father?"

With nothing left to explore on the second island, I rode the rock ship back to the first island in order to explore the throne more completely.

## RETURN TO THE FIRST ISLAND

Upon returning to the docking station on the first island, I consulted my calculations. I currently had 43 active conductor crystals, but if my hypothesis was correct, I only needed 36 (based on the number of buttons on the prison cell's throne control panel). The quickest way to deactivate the seven surplus conductor crystals was to shut off the docking station control panel, which I did.

Now it was time to see if I was right. I climbed the ladder from the docking station to reach the laboratory and slid down the laboratory's windpipe into the prison cell.

With exactly 36 conductor crystals activated, the 36 buttons around the perimeter of the control panel lit up, indicating that the control panel was now receiving power.

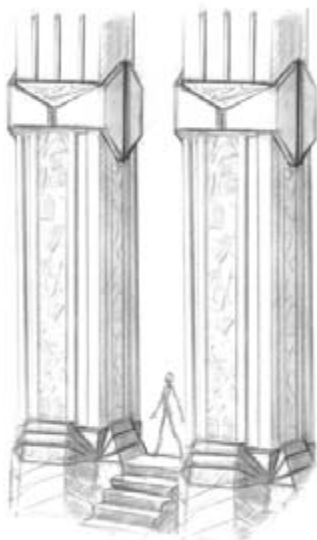

*I turned off the docking station control panel's seven conductor crystals.*



*I returned to the prison cell by climbing the ladder to the laboratory and sliding down the windpipe.*



*The control panel was now active.*

### Figurine Gallery

I pulled the lever on the left side of the control panel down one notch, and the entire throne descended one level below the prison cell, coming to a stop in a gallery of crystal figurines. They all seemed to be carved into the image of the same young girl—was this supposed to be Yeesha? What purpose could they serve?

The throne wasn't the only thing to descend into the figurine gallery. The crystal statues of Atrus and Catherine followed the throne down as well. Without leaving the throne, I took a close look at the statues and touched Yeesha's necklace. The words I heard Sirrus speak in the vision were distinctly unsettling: "Not long now, father, not long before I show you exactly what a 'smart little girl' can do."



*I pulled the lever on the left side of the control panel to ride down to the figurine gallery.*



*Atrus and Catherine's figures descended as well.*

### Frequency Locks

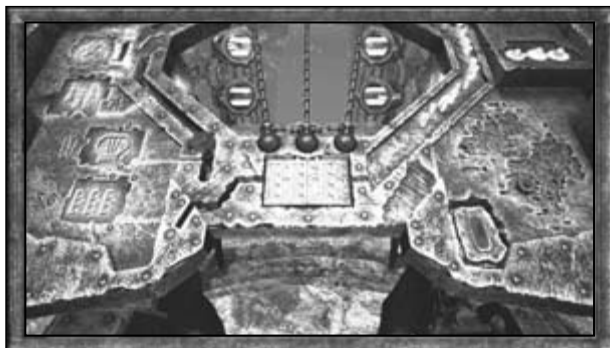

*I pulled the slider again to descend to a room with four locks.*

I pulled the slider again, and the throne sunk another level to a room with what seemed to be four locks, with a crystal in the center of each. The rows of figurines from the gallery above me pivoted and aimed at the center of the ceiling.



*I touched the panel below the lock magnifiers to open it.*

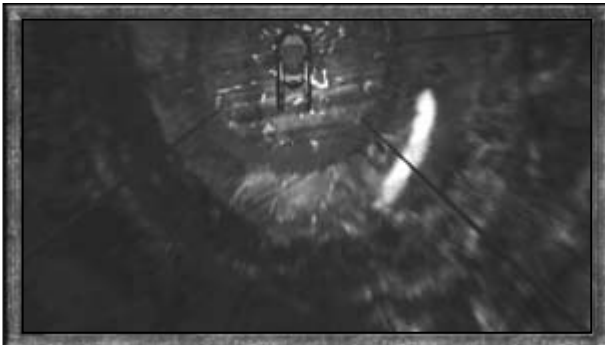

*Pressing the blue button dropped me down farther.*

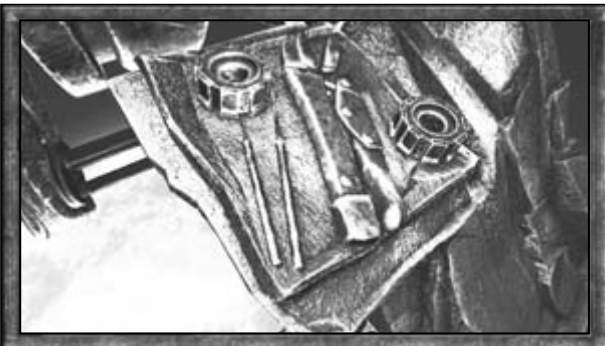

*I glanced down at some tools to my right.*

I touched a panel below the magnifying glasses that were trained on the four crystal locks, and it opened to reveal a blue button.

I pressed this newly revealed button, and my heart leapt into my throat as the throne dropped until it hung from chains below the base of the island. All I could see below me was the undulating green glow of Spire's surface. I resolved to do what I had to do here and get back to the room with the four locks as quickly as possible.

I looked down at some tools to my right and touched Yeesha's necklace. An ungodly groan filled my ears. "No wonder I can't get the right frequency. When they slip out of tune, these cables sound worse than Mother's caterwauling."

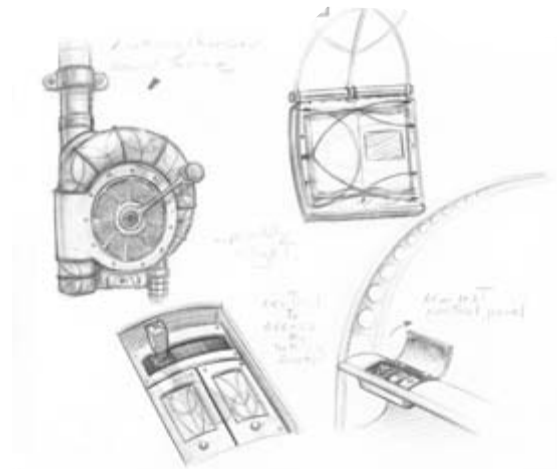

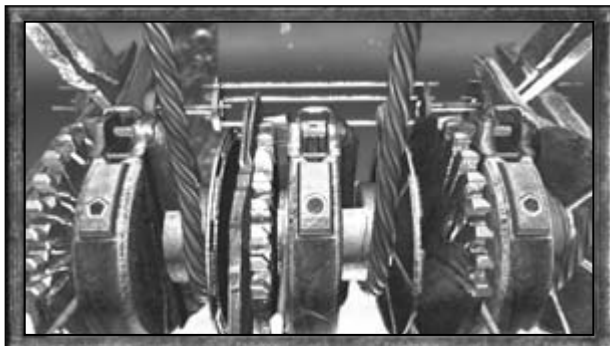

*Three levers, attached to three cables*



*From left to right, I set the levers in the fourth, third, and seventh positions.*

Three levers sat in front of me, each attached to a cable. Presumably these were the cables Sirrus was trying to tune. I noted a shape on each lever: a pentagon, a circle, and a hexagon. Where had I seen these shapes before?

Of course—they were the gauges on the frequency crystals. Sirrus had mentioned in his journal that the crystals emitted tones when discharged. He must have found a way to harness this ability. I consulted my journal and saw that the pentagonal frequency crystal's gauge was marked at the fourth notch from the top. The circular crystal's gauge was marked at the third notch, and the hexagonal crystal's gauge was marked at the seventh notch.

**NOTE** PULLING THE HANDLE AT THE TOP OF EACH LEVER MOVED THE LEVER DOWN A NOTCH. PUSHING THE GREEN CRYSTAL HANDLE AT THE BOTTOM OF EACH LEVER RESET THE LEVER. THE STARTING POINT FOR EACH LEVER WAS THE FIRST POSITION (THERE WAS NO POSITION ZERO).



After setting the three levers in position, I pressed a large black button at eye level to my left, and the throne retracted back up to the room with the four locks.

With the levers below in tune, I turned my attention to the sliders and the four crystal locks. I noticed that when I moved the three sliders up and down, the cables below me resounded with distinctive tones. Certain harmonies caused the crystals in the locks to vibrate with the resonance. Each crystal had one particular harmony that would shake it free of its lock for a short period of time. The trick was finding all four crystals' unlocking frequencies and opening all four simultaneously.



*I touched a black button to my left to return to the four locks.*



*I adjusted the sliders to cause the crystals to react.*



*Crystal #1 (top left): 6-12-4*

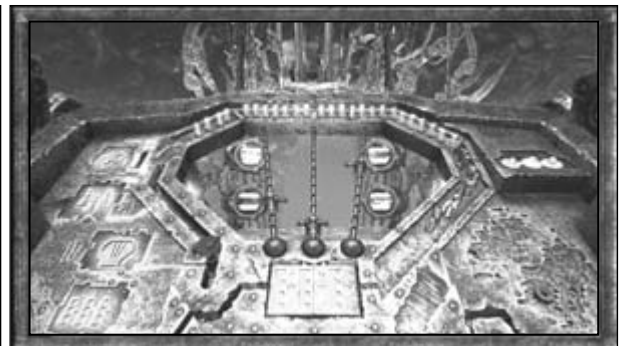

*Crystal #2 (bottom right): 3-1-7*

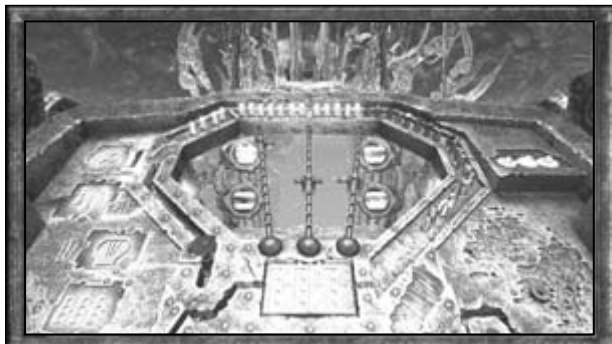

*Crystal #3 (bottom left): 10-5-5*

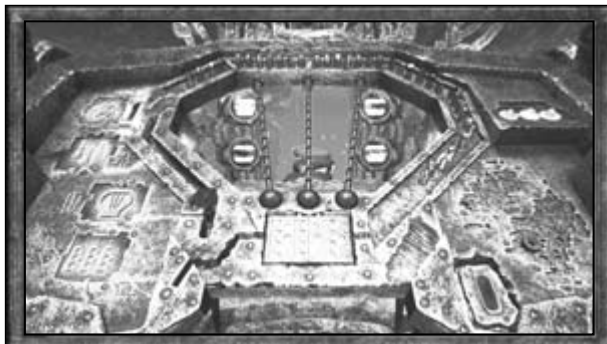

*Crystal #4 (top right): 12-12-12*

Eventually, after some trial and error, I solved the riddle. From left to right, I set the three sliders to 6, 12, 4, which unlocked the top-left lock. I then quickly moved them to 3, 1, 7 to open the bottom-right lock. Switching them to 10, 5, 5 unlocked the bottom-left lock, and sliding them *all to 12* unlocked the fourth one. It took a couple of tries before I could unlock all four before the first one locked itself again, but eventually I did it.

Once I had unlocked all four locks simultaneously, a pathway appeared. I pressed the blue button on the right arm of the throne to retract the control panel and crossed the stepping stones.

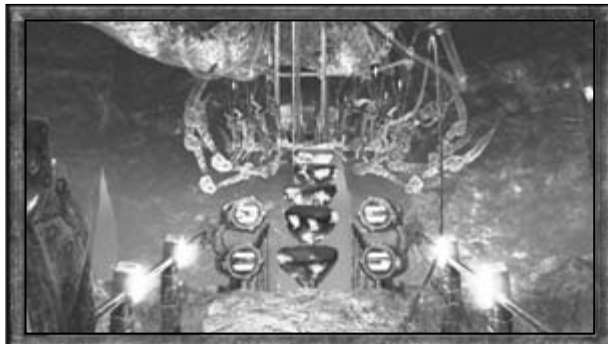

*Unlocking all four locks simultaneously revealed a pathway.*

## Bomb Factory

The path ended at a metal platform surrounded by spidery arms. It looked as if something had fallen onto the platform from high above it. Looking carefully at the rubble, I recognized it as a part of the *nara* linking chamber I had appeared in when I first arrived on Spire.

I saw a small crystal figurine in the shape of Yeesha on a bench and took a closer look at it. It was encased in a metal shell, with a second crystal suspended above it. Yeesha's necklace revealed SIRRUS's contemplations on how best to keep the crystals from touching each other until he could "use them."



*A small figurine in a metal casing*

## Isolating a Charged Frequency Bomb



*DRC scientists have long been intrigued by the mysterious substance that SIRRUS created to keep his frequency crystal bombs isolated. They believe that the simplest way for him to maintain isolation would have been to freeze the newly charged crystals immediately, then spray them with water and wait for an ice coating to form. SIRRUS never would have been satisfied with this answer, though, as it offered no guarantee that the ice wouldn't melt before his bombs could be used.*

*Whatever notes SIRRUS kept on the substance were destroyed when the top half of Spire's linking chamber plummeted into his bomb factory. All we really have left to go on is this travel journal—an account which spends more time dwelling on SIRRUS's motives than it does his scientific advancements.*



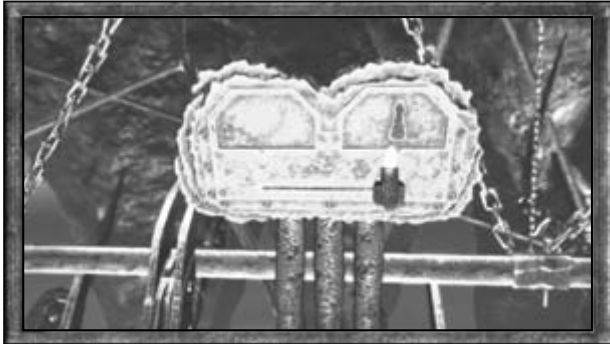

*A selector switch—I moved it to the right.*

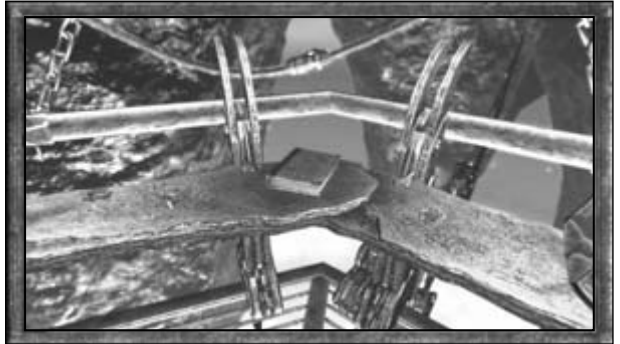

*A second journal, next to the crystal figurine*

Next to the crystal figurine was a selector switch. I pushed it to the right so that the switch lined up with the image of a figurine from the figurine gallery.

I found another one of Sirrus's journals on the bench next to the figurine. It related Sirrus's discovery of the visitor's chamber that Atrus wrote into Spire 15 years after Sirrus's imprisonment. Sirrus had no luck convincing Atrus to release him, but he noticed that Catherine's emotions were much easier to manipulate.

Sirrus also remembered that he could excite the molecular structure of any matter, given the right frequency. It was then that he hatched the plan to find a way to detonate the dividing wall that separated his prison from the Tomahna Linking Book. All he needed was enough electricity (the conductor crystals) and the right instrument (the frequency crystals), as well as a sample of the chamber wall itself. He deduced that the chamber wall was made of the impenetrable D'ni stone *nara*, and so he convinced Atrus to give him the *nara* chess pieces so that he could experiment with them in secret.

Sirrus's resentment of Yeesha came through clearly in his writing as well, as if the dozens of crystal figurines of her didn't speak clearly enough to his obsession with his sister. He viewed the fact that Atrus had taught her the D'ni language—which was also used for writing Ages—as a slap in the face. He ominously vowed that if Atrus insisted on giving Yeesha that ability, Sirrus would ensure that Atrus was also giving it to him.

The last entry in the journal caused my blood to run cold: "105.5.28: I have found the frequency..." I realized that he probably wrote these words not long before Atrus had decided to contact me and get my opinion as to whether or not Sirrus should be released.

The only other items of note were two devices, filled with the green liquid I saw on Sirrus's desk in the garden. One was labeled "10-5-5," and the other was labeled "12-12-12." A movable chute under the devices was positioned under the "12-12-12" device; I moved it to the left so that it sat under the "10-5-5" device. When I touched Yeesha's necklace, I saw a vision of each machine dropping a crystalline figure into the chute below. The figures looked like the one sitting on the bench.



*Figurine collectors?*

I was starting to understand the devices on this platform. Unless I missed my guess, it was a bomb factory. The figurines were actually explosive devices, triggered by particular frequencies. I guessed that the green substance that Sirrus had engineered from the plants in his garden was a nonconductive insulating coating. Moving the chute out from underneath the "12-12-12" device meant that, were a figurine to fall through it, it would not be captured but would instead hit the ground, shattering its nonconductive coating, which would cause it to discharge its unique frequency.

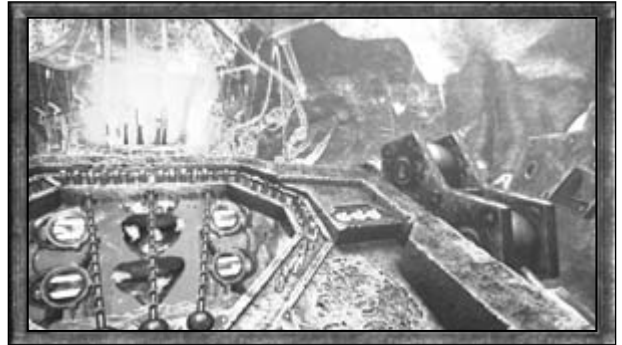

*I returned to the throne and set the sliders to "12-12-12"—explosion resulted.*

I decided to test the theory. I had already powered up the factory by moving the switch to the right so that it pointed to the image of the figurine. Returning to the throne, I set the sliders all the way up to "12-12-12." I watched as a figurine fell from the figurine gallery overhead and traveled through a tube to the figurine collector. With the collector chute moved out from under the "12-12-12" figurine collector, the figurine fell out of the bottom and touched the ground, which caused it to discharge its electricity and emit the *nara*-shattering frequency. Not only did this confirm my suspicions, it also detonated the *nara* rubble in the center of the bomb factory.

I returned to the bomb factory and investigated the area where the rubble had been. Hanging near the base of what I realized was an elevator, there was an amulet. I looked at it closely and saw a small handle in the middle of it. I pulled this handle, and the amulet revealed six colored circles around its perimeter. I had no idea what it could mean, so I took a picture of it and resolved to ponder its significance later.



*I stepped onto the rubble's former location and found an amulet.*

### ***The Amulet's Unreliable Color Codes***

*For many years, this picture of SIRRUS's amulet was the only evidence the DRC had that such a device even existed. Then in May of 2002, a daring team of Canadian investigators linked to Spire and—at considerable risk to their own lives—managed to retrieve the amulet itself.*

*Unfortunately, time had taken its toll by then. Every person who views the amulet today reports seeing a different combination of colors when it is triggered. It's unclear whether the colors in the amulet itself are at fault, or if the stranger's photograph has simply faded. Either way, the only way one can ever know the exact arrangement of colors that SIRRUS used is to experience the adventure firsthand.*

I pulled the elevator's switch, but nothing happened. It wasn't getting any power. I stepped off of it and, on a whim, slid the switch near the enclosed figurine back to the left so that it was no longer pointing at the icon of the figurine.

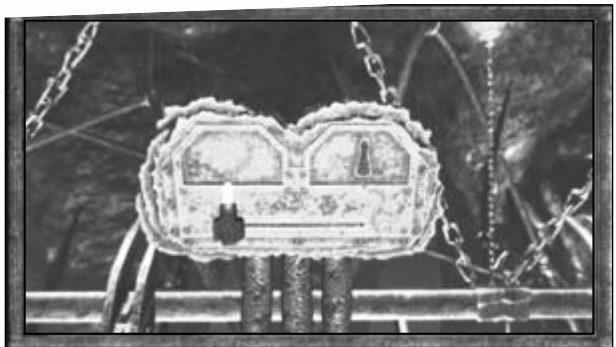

*I slid the switch back to the left.*

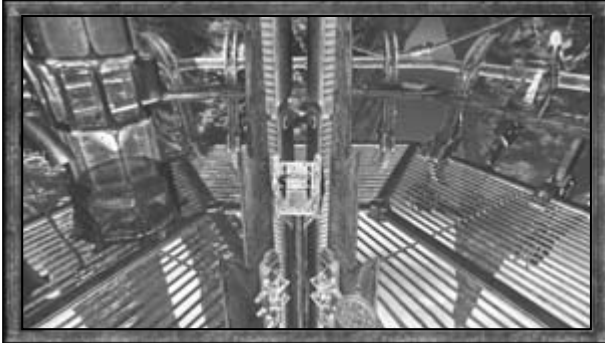

*I pulled the lever in the elevator and rode all the way back to the top of Spire, near my linking point. I realized that if I ever needed to return to Spire's bomb factory, I could use this elevator to quickly and easily reach it.*



*I quickly returned to the Tomahna Linking Book and left Spire.*

I had accomplished my goals in Spire. I understood what Sirrus had done and how he had done it. However, I had failed in my quest to find Sirrus himself or Yeesha—it pained me to admit that I did not know if she was alive or dead. Hoping that Atrus had returned to Tomahna in my absence, I ran back up Spire's stairs to reach the Tomahna Linking Book and used it to return to Tomahna.



## Tomahna, Part Three

//

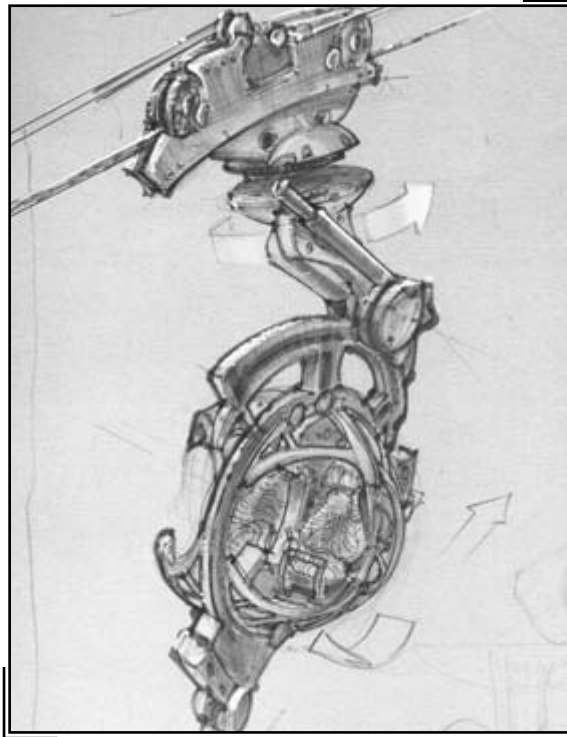

### RETURN TO TOMAHNA

My ruminations on Sirrus's intentions were abruptly interrupted the instant I returned to Tomahna. From my vantage point inside the hidden linking chamber, I saw a disheveled figure walk out onto the balcony of one of Tomahna's buildings, open a Linking Book, and disappear. The book fell past the balcony to land on a ledge below it. Recalling Tomahna's layout, which had become as familiar to me as my own handwriting over the course of my many visits to Atrus

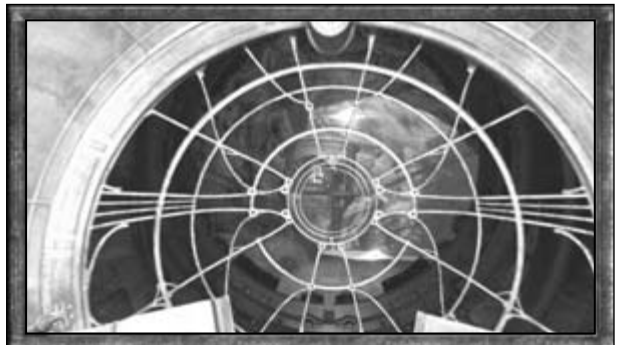

*I saw a disheveled figure walk out onto Yeesha's balcony and link.*

and his family, I realized that the figure had linked away from Yeesha's room. If I was to have any hope of finding Yeesha, I had to ignore the Haven Linking Book in front of me for now, get over to Yeesha's bedroom, find that Linking Book, and use it to follow the mysterious stranger.



*I rode the fireplace elevator back up to Atrus and Catherine's bedroom.*

I retraced my steps to Atrus and Catherine's bedroom by pulling the lever inside of the linking chamber to reveal its exit, pressing the button on the exterior of the fireplace elevator to summon it, and riding the fireplace elevator back up to the bedroom.

As I did, I contemplated the identity of the stranger I had seen. He was too far away and linked too quickly for me to get a good look at him, but I didn't think it was Sirrus. Even after a 20-year imprisonment, I couldn't imagine the vain

Sirrus allowing his appearance to deteriorate so completely. That left Achenar as my best guess. I recalled that he preferred the wilder, more primal Ages in contrast to Sirrus's appreciation for sophisticated technology and cultures, which would explain the almost feral look of the stranger.

I had to strongly consider the idea that Sirrus and Achenar were in this plot together. They both had the same reason to take revenge upon their father, and 20 years might have been enough time for them to put aside their differences and decide to work together. This thought brought me no comfort. Stopping Sirrus would be difficult, but countering both brothers working as a team would be nearly impossible without assistance.

But there was no time for self doubt. I needed to reach that Linking Book, and pondering the unknown challenges ahead of me wasn't going to help me achieve my immediate goal. I left Atrus and Catherine's bedroom and retraced my steps to the elevator I had ridden from Atrus's laboratory. Stepping around the elevator, I remembered the moveable bridge that connected my present position with Tomahna's main living area. Currently, the bridge stretched between the main living area and Yeesha's bedroom.



*The moveable bridge connected the main living area (right) to Yeesha's bedroom (left).*



*I pulled the lever to move the bridge to my current location.*

I pulled the nearby lever to the right, and the end of the bridge that rested at the edge of Yeesha's bedroom rose up and swiveled to my present location. I walked across the bridge to reach the main living area.

### Main Living Area

As eager as I was to reach Yeesha's bedroom and find that Linking Book, I decided to take a quick look around the main living area. If there was one thing I had learned from my dealings with Atrus's family, it was that there was no such thing as being too observant. Also, although I couldn't explain it, Yeesha's necklace had already shown me so many valuable clues that I couldn't risk overlooking another one.

Yeesha's textbooks lay open on a table on the balcony of the main living area. I approached them and found that they provided a very useful English-to-D'ni phonetic translation guide. Next to them lay a pad of paper and a quill on which Yeesha had practiced writing her D'ni name. Touching Yeesha's necklace showed a scene of Atrus teaching Yeesha to write D'ni and reminding her that D'ni writers didn't write Ages, they wrote *links* to Ages, an important distinction. I took a picture of the D'ni textbook for future reference and continued exploring the main living area.

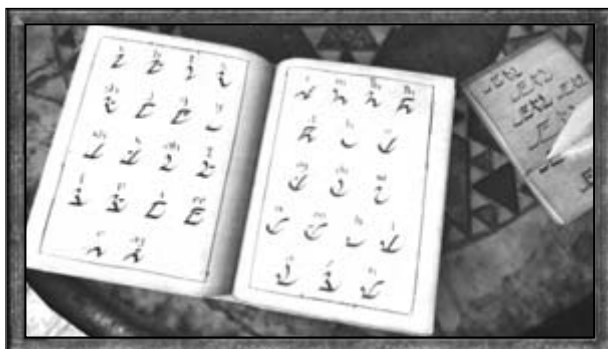

*Yeesha's schoolbooks provided an English-to-D'ni translation.*



*Portraits of the two brothers*

On the mantle above the embers of a dying fire were portraits of the two brothers. Achenar's bearded visage matched the glimpse I'd seen of the stranger outside of Yeesha's room.

Moving counterclockwise around the fireplace, I saw a portrait of Yeesha hanging on the wall and wondered if Atrus had consciously separated her picture from her brothers'. Next to the portrait was a chessboard with the pieces arranged in the same positions as the ones on Spire. Touching Yeesha's amulet as I examined the board gave me a glimpse into Atrus's logic. SIRRUS had scoffed at his father's decision to leave his queen vulnerable, but Atrus was using his queen as bait for SIRRUS.



*The same game of chess SIRRUS was playing on Spire*

"If he's thinking ahead, he'll see the trap I've set and leave my queen alone," said Atrus. "But if he's not, I may just win this game in two moves."

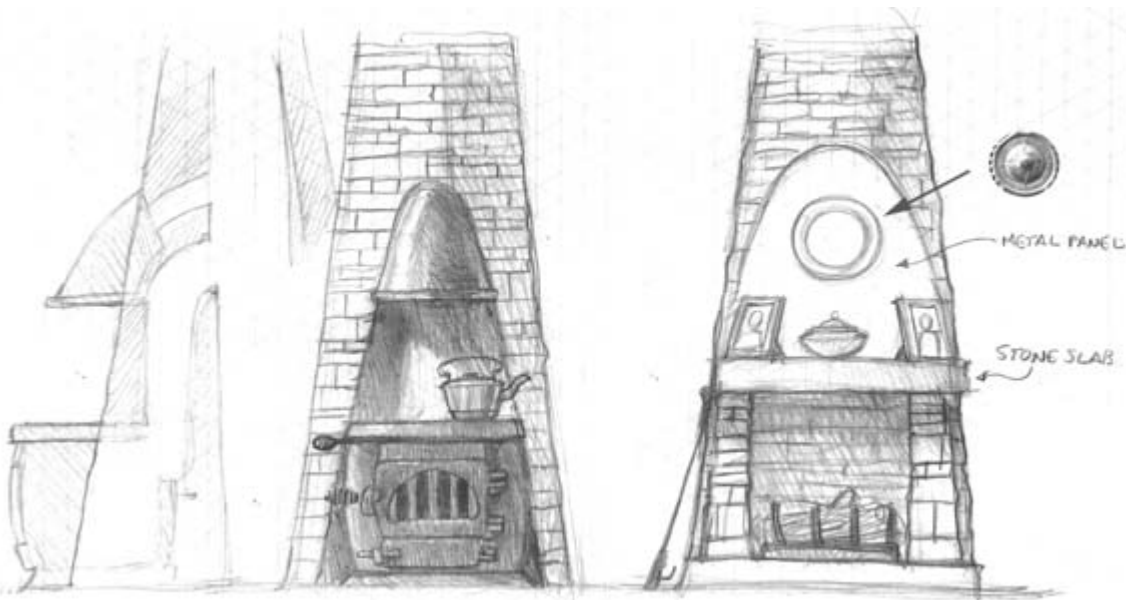



### **Two Can Play That Game (the Psychology behind a Chess Match)**

The father-son chess game that was in progress at the time of the Prison Age escapes has turned out to be something of an eye-opener. From the stranger's account of events, it's clear that SIRRUS was using this interaction to trick Atrus into aiding his escape. But did SIRRUS realize his father was also using the match as a way to see if his son had reformed?

Atrus's strategy was simple but brilliant. By moving his white queen to the A3 position, Atrus offered SIRRUS a prize almost too tempting to pass up. If SIRRUS ignored it, he could show evidence of his redemption and possibly win the game. But if he allowed his desire for power to blind him, he'd most certainly lose the game three moves later.

- 1) White Queen moves to A3 (Atrus's first move).
- 2) Black Bishop takes the White Queen (SIRRUS's counter move).
- 3) White Bishop takes the Black Pawn (Atrus has "Check").
- 4) Black Queen takes the White Bishop.
- 5) White Knight moves to G5 (Atrus has "Checkmate").



*Atrus moves first, into position.*



*SIRRUS makes his counter move.*

The evidence speaks for itself.

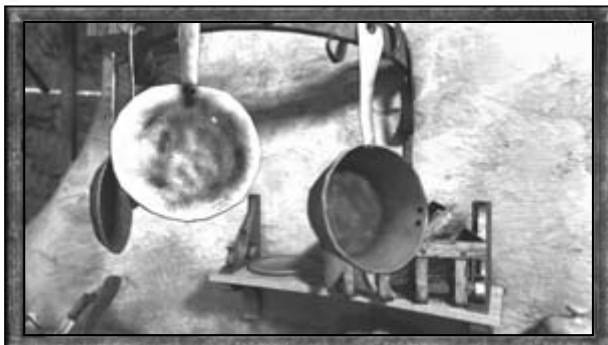

*A scorched pan, evidence of Atrus's (lack of) culinary skill*

Continuing into the kitchen, I found that Yeesha's necklace reacted to a scorched hanging pan. Yeesha's necklace revealed a memory of her chiding her father for burning the pan and suggesting that they hide the evidence before Catherine returned.



*The stove resonated with one of Yeesha's memories of her mother.*

The stove behind me was still warm to the touch. Yeesha's necklace allowed me to hear the echo of a conversation between Yeesha and her mother. "Your father's linking home tonight," said Catherine. "Why don't we use the special plates?"

Apart from a portrait of Atrus and Catherine hanging from the wall, there was nothing else to see in the living area. I walked back out onto the balcony.

## Yeesha's Bedroom

From the living area balcony, I flipped the switch to swing the moveable bridge so that it connected the main living area to Yeesha's bedroom. I wasted no time crossing it. From Yeesha's balcony, I could see the hidden linking chamber's cave, so I knew that the Linking Book must have been directly below me. But how was I supposed to get down there without breaking my neck?



*I moved the bridge to Yeesha's bedroom.*



*Yeesha's bedroom had been ransacked.*



*Yeesha's journal sat on her bed.*

I walked into Yeesha's bedroom and was taken aback by the state of it. It looked as if Achenar had violently ransacked the room in search of something—possibly Yeesha herself. I examined the room carefully for clues.

I found Yeesha's journal on her bed and skimmed through it quickly. It gave accounts of Yeesha's day-to-day activities from her 10-year old perspective. Notable entries included her father preventing her from accepting a gift of bones from Achenar and several entries regarding visits to an Age called Serenia (including the crystal combination for the Age, which I photographed).

The people of Serenia apparently had some sort of device called a Memory Chamber, which was supposed to store a person's memories after death. The Memory Chamber was guarded by female-only Protectors, one of whom ("Anya") had apparently become somewhat of a role model for Yeesha.

Yeesha claimed to have seen some sort of creature made entirely of water on Serenia. Anya referred to it as a "spirit guide," which was essential for visiting the memories of others in some sort of "Dream World" through the use of the Memory Chamber. Yeesha was so taken with the concept that she told Sirrus about it, and he gave her the gift of a spirit guide statue. My heart sank upon reading this, knowing what Sirrus's crystal statues were actually used for.

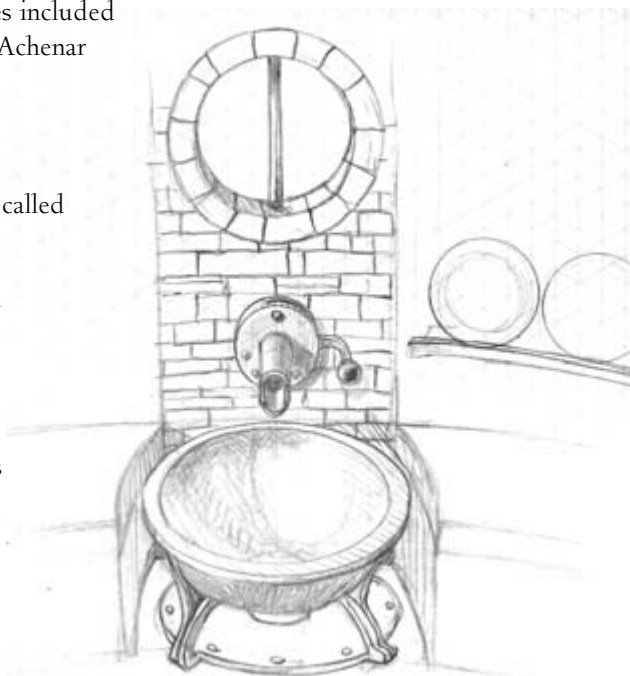

### **Better to Give Than Receive**

*Recently, a rather insightful observation has been made concerning the origin of Yeesha's interest in Serenia. It seems that the young girl did not start linking to the Age until well after her visits with both brothers began. This, then, begs the question: how exactly did Yeesha first learn about Serenia?*

*We know that Sirrus gave Yeesha a crystal carving of a Serenian water spirit several months after she began visiting Serenia. We also know that Achenar gave her a gift too, although what exactly that gift was has never been discovered. Viewed in the light of this new observation, it seems apparent that neither brother's gift was completely appropriate.*

Yeesha also noted that her father changed the lock on her bookshelf and that she had decided to use her family's names as the combination for it.

The journal ended with Yeesha relating how Anya was teaching her to dream on Serenia and how she had given Yeesha the necklace that I now carried. Although I initially found the accounts of Serenia's Memory Chamber and Dream World to be a bit far-fetched, I couldn't dismiss them altogether after seeing the evidence of the necklace's power for myself.

I examined a robe hanging near Yeesha's bed and touched the necklace to hear Yeesha pleading with her mother to let her wear the robe. Catherine told her that she couldn't wear it until the ceremony on Serenia, during which Yeesha got her necklace.



*A robe hanging near the bed held the memory of a conversation with Catherine.*

I found one of Sirrus's crystal figurines on Yeesha's desk. Examining it with the necklace revealed that this was the water spirit sculpture that Sirrus had carved for her. I unconsciously took a step back from it, fearing another explosion.

The only other thing of interest in Yeesha's room was the bookshelf near the desk, which held sixteen books in two rows of eight. Below the books was a sheet of paper with glowing ink that declared Yeesha to be a "child of water." That didn't seem relevant to my immediate goals, so I put it aside for the moment.

Each book on the shelf had a D'ni word written on the spine. Remembering Yeesha's journal, I realized that this was actually a locking mechanism for something. Yeesha had mentioned that the order of ages of the people in her family was the code, so I used her D'ni textbook to translate the names.

I couldn't quite remember the birth order of Sirrus and Achenar, but in reviewing my journal, I remembered the etching I'd found at the very beginning of my journey in Catherine's garden. Translating the names on it, I found that it was a family tree that gave the order of the family member's ages (from eldest to youngest) as: Atrus, Catherine, Achenar, Sirrus, and Yeesha.

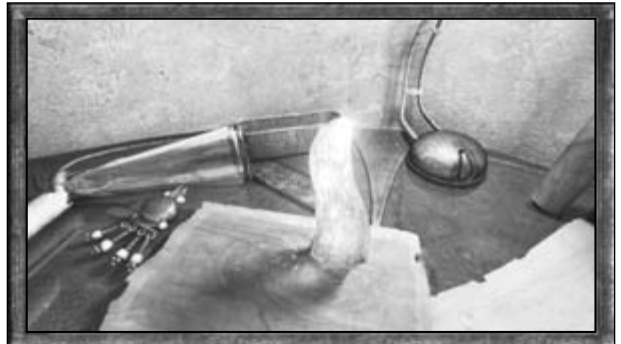

*One of Sirrus's crystal figurines sat on the desk.*



*The bookshelf that Yeesha referred to in her journal*



*The etching in Catherine's garden was a family tree.*

I pushed in the following five books in order from eldest to youngest.

Book Order		
Name	Shelf	Book # (from Left)
Atrus	Bottom	Fourth
Catherine	Top	Sixth
Achenar	Top	Eighth
Sirrus	Top	Third
Yeesha	Bottom	Sixth



*I pushed the five books in order from eldest to youngest.*

As soon as I finished pushing in the fifth book, the bookcase slid away and revealed a ladder leading down a shaft. Realizing that descending this ladder would bring me closer to Achenar's Linking Book, I climbed down the ladder.



*The bookcase slid away to reveal a hidden ladder leading down.*

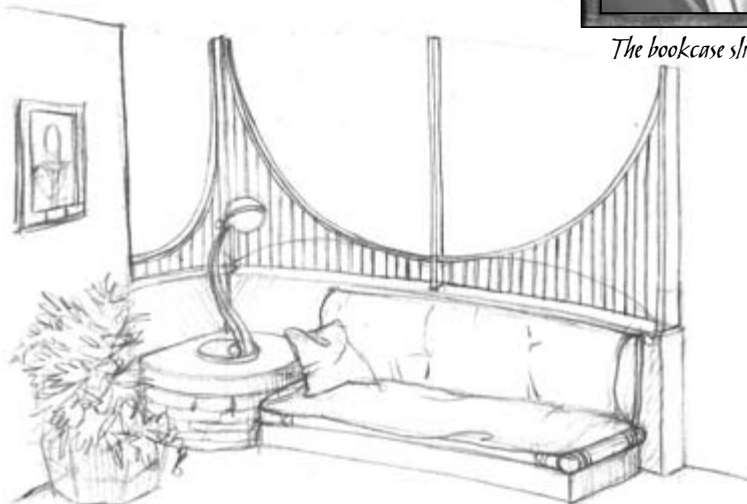

### Yeesha's Secret Cove



*The ladder led to a secret cove.*

The ladder ended at a wooden platform that ran along a secret cove. I could see the hidden linking chamber in front of me and realized why Atrus had sealed off the passage leading down here. Not only did it help to ensure that no one would stumble upon the existence of the hidden linking chamber, it was also a security device that put a line of defense between the linking chamber and Yeesha's bedroom, should the brothers ever escape from their prisons.



*Achenar's Linking Book, right where I saw it fall*

I walked to the end of the wooden platform and saw the Linking Book that Achenar had used to vanish from Tomahna. Opening it, I saw that its linking panel showed an Age that I had not yet seen. It was different from the linking panels of the Spire and Haven books, and it didn't resemble any of the dozens of other Ages I had linked to in my 20-year friendship with Atrus.

I was wary of linking blindly into a new Age, especially one that I had seen Achenar link into. For all I knew, this could have been an attempt to trap Atrus in another Prison

Age—or worse. But I knew that my sense of self-preservation might cost Yeesha her life. My old friend might forgive me for not doing everything I could to save his daughter, but I could never forgive myself should something happen to her. And so, with a prayer on my lips, I placed my hand on the linking panel.



ICEBOX

# Serenia, Part One

//



## ARRIVING IN SERENIA

Any anxiety I had about following Achenar through the Linking Book on Tomahna dissipated as soon as I arrived. My linking point to the idyllic paradise known as Serenia was a naturally formed stone niche in a placid garden of stone pillars. A wooden footbridge spanned a crystal clear brook ahead of me. I could tell why Yeesha liked spending her time here. I had never seen such natural beauty in my life.



*I linked into a garden of stones.*



I turned around and saw a Tomahna Linking Book at my feet, lying on the ground instead of on the nearby pedestal. Examining the pedestal, I touched Yeesha's necklace and saw a vision of her reaching for the Linking Book in a panic, only to be pulled away by an unseen assailant's hand—Sirrus or Achenar's, I guessed. During the struggle, the book fell off of the pedestal and landed in its present location. This disturbing vision shocked me out of the reverie that Serenia had lulled me into, and I set off down the path in front of me without delay, hoping that I wasn't too late to save Yeesha from whatever diabolical fate her brothers had in store for her.



*Tomahna Linking Book and pedestal*

### ***The Unprotected Linking Cave—a Linguist's Faux Pas?***



*Controversy surrounds the translation of these three paragraphs in the stranger's travel journal, largely because their description of Serenia's linking cave is difficult to accept. Everything we've learned about Atrus over the years suggests he would never leave a Tomahna Linking Book unprotected. Yet if this translation is right, then the one he placed in Serenia was open to anyone.*

*To accept the truth behind what many prefer to view as a translator's faux pas, one has to understand Serenian culture. They are an extremely peaceful people, in part because they never forget their own past. Also, many of the fears and aggressions we humans tend to experience are alleviated for Serenians through interactions with their ancestors. Certainly, Atrus spent enough time in the Age—both before and after Yeesha began visiting there—to believe that his Linking Book was safe.*

*Besides, if it wasn't, he'd set up enough safeguards in Tomahna to protect him.*

As I reached the second footbridge along the path, I turned to my left and saw what appeared to be some sort of irrigation control device. My natural curiosity about the engineering of Serenia's waterways would have to wait for a more peaceful time, however.

## Stone Forest

I crossed the second footbridge and entered the stone forest just in time to see Achenar running down the right-hand path ahead of me. So surprised was I to see him that I froze for an instant and was unable even to call out. In the second that it took for my shock to pass, he was already out of sight.

I dashed after Achenar, but my hesitation cost me my chance to catch him. To my dismay, the path forked into several sections, and there was no way of telling which way he had gone. After following a few false leads, I found myself back at the second footbridge, no closer to finding Yeesha than I was before.



*I saw an irrigation device near the second footbridge.*



*Achenar was only a few steps ahead of me.*



*The path split into several sections.*

**NOTE** DURING THE TIME I SPENT IN SERENIA'S STONE FOREST, I CAUGHT SEVERAL GLIMPSES OF STRANGE APPARITIONS. IT SEEMED THAT EVERY FEW MINUTES, I SAW A FIRE THAT BURNED BRIGHTLY FOR A FEW SECONDS, OR A COLUMN OF WATER RISE UP FROM A POOL, OR A MINIATURE WHIRLWIND IN A CIRCLE OF STONES. ALTHOUGH BIZARRE, THEY DID NOT SEEM INCLINED TO TROUBLE ME—IF THEY WERE INDEED SENTIENT AT ALL.



*I crossed the stream at the small suspension bridge.*

From the point where I lost Achenar, I crossed a small suspension bridge and turned left at the fork in the stone path beyond it. Continuing down that path, I came to a T-intersection at the end of it. I turned left and went right at the next fork, choosing to approach a set of stairs leading down to a stone arch instead of crossing another wooden footbridge.

## Monastery



*Path leading to the monastery entrance*

The stone arch marked the entrance to the area around Serenia's monastery. As I approached it, a woman greeted me with surprising familiarity. She introduced herself as one of Serenia's Protectors by the name of Anya, a name I recognized from Yeesha's journal.



*Anya claimed to know a great many things.*

Anya claimed that my coming was foretold in her dreams. She knew I was looking for Yeesha but sadly admitted that she had not seen her since giving her the necklace two weeks ago. She suggested that I continue to the Memory Chamber in search of advice. When she had finished speaking, Anya began ringing a large bell overhead to call her sisters together.

**NOTE** I FOUND THAT BY RETURNING TO THIS SPOT LATER AND TOUCHING YEESHA'S NECKLACE, I COULD HEAR AN ECHO OF ANYA'S ADVICE TO ME.



*I walked straight through to the next stone arch.*



*Sirrus rose from the water in some sort of bathysphere.*

I left Anya at the bell and walked straight toward the stone arch in front of me, choosing not to investigate the Hall of Spirits to my left or the small pavilion to my right. As I passed under the arch, I descended the steps beyond it and turned left to walk down another set of stairs. From the top of the stairs, I saw the Memory Chamber, a structure that resembled a giant budding rose.

As I reached the bottom of the stairs, a pulley mechanism squealed into motion, and a bathysphere containing Sirrus rose from the pool in front of me. He was holding a dark spherical object in his hand and admiring it with some pride. However, as soon as he noticed me, he thrust it into a sack and withdrew one of his frequency crystal bombs, which he used to destroy the bathysphere as he exited it.

I ran down along the pathway as fast as I could to reach the other side of the bathysphere, but the frequency bomb's explosion and the meandering pathway gave SIRRUS too much of a head start. He had vanished, leaving the smoldering remains of the bathysphere behind. I touched Yeesha's necklace as I examined the docking mechanism and heard SIRRUS and Achenar arguing over using the device. SIRRUS insisted that they must take the risk of being caught using the bathysphere (referred to as a "harvester") because it was the only way to reach the "empty memory globes" below the water. Achenar reluctantly agreed but vowed that SIRRUS would steal the "filled" memory globes if they needed them.

There was nothing else to do at the harvester, so I turned around and backtracked slightly to a statue that I had passed in my mad dash to try and catch SIRRUS. Resembling a woman holding a large tray or bowl, the statue held the memory of SIRRUS and Achenar's presence at a Serenian funeral. SIRRUS in particular was interested in whether the ceremony influenced the "transfer" (presumably of memories since I was also standing in front of the Memory Chamber itself).

## Memory Chamber

After investigating the statue, I stepped cautiously into the Memory Chamber, which did not seem to have been constructed as much as it had been grown. Iridescent mosses lined the walls and floor of the small structure, radiating glowing blue spores that left me slightly lightheaded.



*The bathysphere was ruined, but examining its docking mechanism proved useful.*



*I backtracked slightly to a strange statue outside of the Memory Chamber.*



*The Memory Chamber*

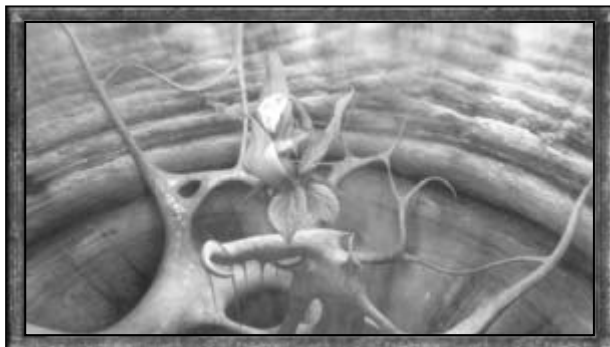

*The heart of the Memory Chamber?*

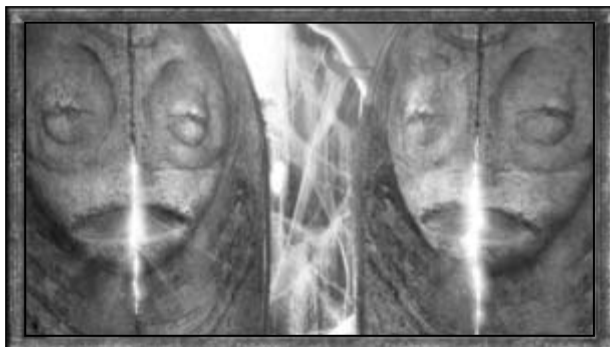

*I touched the four masks in the chamber and saw Yeesha, SIRRUS, and Achenar.*

In the center of the Memory Chamber was a plant that beat like a heart. If the Memory Chamber was indeed a living organism, this was obviously one of its most vital organs.

Toward the rear of the Memory Chamber, on either side of its “heart,” were four stone masks, each emitting blue light from a narrow vertical crack. I examined each mask in turn, placing my hand in each mask’s glowing mouth and touching the surface of the Memory Chamber itself. Each time I did so, I saw one of four short, disorienting visions. Two of them showed Yeesha struggling against her bonds. The third revealed Achenar stealing a triangular stone approximately three feet in height. And the fourth was of SIRRUS holding an egg-shaped stone (a memory globe?) and smiling. What did they all mean?

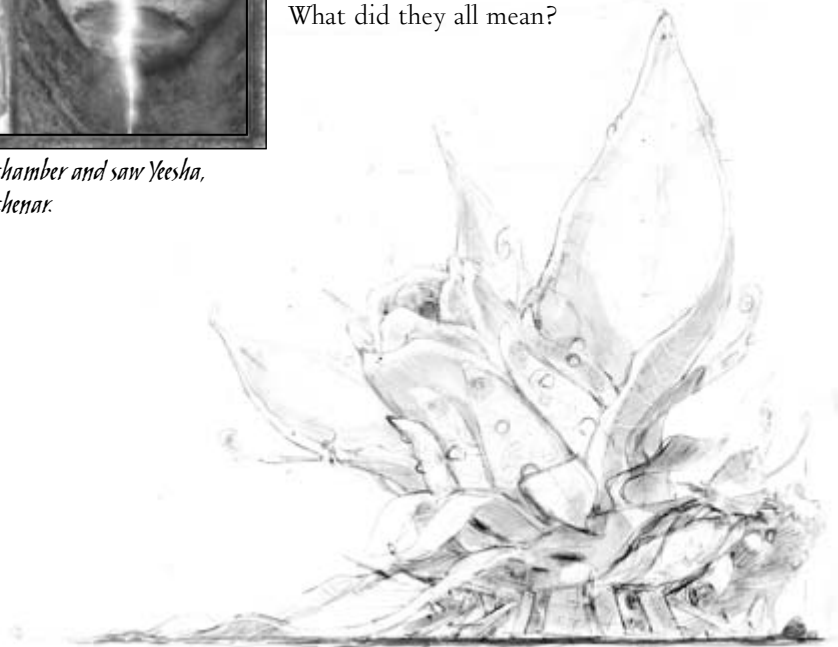

### *Hallucinogenic Fungus or Sentient Being?*

*The visionary flashes of Yeesha and her brothers that the stranger describes experiencing here may seem unbelievable to many. Yet those who have studied Serenian ecology find them to be perfectly plausible.*

*Writes ecologist P. F. Dindly, in a 27-page report on the subject: "The Memory Chamber is not just a structure used by Serenians to store the memories of their ancestors. She is a beautifully sentient life form who employs pollens and memory globes to communicate with other life on the Age."*

*According to Dindly, the visions people experience when inside the Memory Chamber occur in only one of two places: when touching a stone face on the chamber's first floor or when gazing up at another mask in the second level meditation alcove. "Both places," he writes, "are in close proximity to the fungus' delicate stamen. The pollens emitted by this stamen may have a non-harmful hallucinogenic component which makes one susceptible to the Chamber's messages."*

*Interestingly enough, those same pollens have been found to exist inside the Protectors' necklaces, which have long been admired for their unique communicative ability.*





*Set of stairs behind the heart of the Memory Chamber*

I climbed the set of stairs that began on the left side of the Memory Chamber, but they only led up to a small room with a stone slab approximately six feet long. A mechanism above it was probably used for the Serenian funeral rites that Sirrus and Achenar had witnessed.



*The Protector Yannin met me near the ruined harvester.*

I left the Memory Chamber and began backtracking along the stone path, satisfied that I had seen all that the Memory Chamber had to offer me at present. As I passed the bombed harvester, a Serenian Protector by the name of Yannin approached me. Yannin explained that the glowing lights of the Memory Chamber were the stored memories of her people's ancestors, and that the Memory Chamber allowed future generations to visit their deceased family members in dreams. Empty memory globes grew in the water below the Memory Chamber, but without the harvester, there was no way for the Serenians to reach them, and therefore no way to preserve future memories. As she left to inspect the damage to the harvester, Yannin recommended that I visit her sisters for advice in the Hall of Spirits after they had awoken from their dreaming.



*I followed Yannin to the harvester controls.*

Instead of going directly to the Hall of Spirits, I followed Yannin to the harvester controls. Her initial evaluation of the state of the harvester was not good, but she recalled that there was another harvester near an older Memory Chamber that was abandoned due to toxic pollens. Yannin suggested that parts from that harvester could be used to fix this one.



**NOTE** AFTER MY CONVERSATIONS WITH YANNIN ENDED, I WAS ABLE TO TOUCH YEESHA'S NECKLACE WHILE EXAMINING EACH SIDE OF THE HARVESTER AND RELIEVE THEM.



*The Hall of Spirits*



*Serenia's Protectors were still dreaming.*

I entered the Hall of Spirits and saw three Protectors sitting on benches between smoking censers. Ornate masks hid their faces from me, but their rigid stillness indicated that they were still dreaming. I left them to their visions and exited the Hall of Spirits.

Taking my leave of Yannin, I backtracked up the two flights of stairs that returned me to the four-way intersection I'd come through after speaking with Anya. I turned right at the intersection to enter the Hall of Spirits.



## ***Serenia's Monasteries: Customs across the Age***

*It's unfortunate that the stranger was only able to visit one monastery on Serenia, for it is not the only one that exists there. Nor is the village the monastery serves Serenia's only village. They are, however, two of the oldest such places—as evidenced by the fact that not just one, but two Memory Chambers can be found there.*

*Regardless of the monastery's longevity, the customs that the stranger observed after arriving have proven to be universal throughout the Age. Monasteries are always staffed exclusively by women, who can decide to become a Protector at any stage in their lives. Their primary responsibility is to protect and monitor the Memory Chamber's growth. They do have several other important functions, of course—as the stranger's account eventually describes.*

From the Hall of Spirits, I walked directly across the intersection to the pavilion surrounded by butterflies at the end of it. I found Anya there feeding the butterflies. Anya told me that Yeesha appreciated the butterflies more than any member of her family, certainly more than Sirrus and Achenar did when they lived on Serenia before their imprisonment. The brothers seemed much more interested in the Memory Chamber than the fauna.

Anya's words gave me pause. It was possible, even likely, that the conversations between the brothers that I heard through Yeesha's necklace could have been 20 years old, before their imprisonment. After all, several of the Spire visions I saw must have been from Sirrus's first days in the Age. Although it gave me some hope that only one of Atrus's sons might still be a threat, that was far from a proven prospect at present.



*Anya fed butterflies from the pavilion*

Before leaving the pavilion, I looked down at the tile beneath my feet and examined it, holding Yeesha's necklace as I did. I heard Yeesha and Anya discussing the pattern, which represented the entire area and the way the waterways connected all of it. I took a photo of it for future reference.



*An intricate patterning on the tile of the pavilion*

### Ceremonial Site



*I headed for the ceremonial site section of Serenia.*

Leaving Anya to her butterflies, I walked into the ceremonial site section of Serenia by turning right at the four-way intersection and proceeding straight along the stone path, rather than descending the stairs that would take me back to the ruined harvester.



*The discontinued Memory Chamber*

As I crossed a long, wooden suspension bridge, I caught sight of what I guessed was the old Memory Chamber that Yannin spoke of. Instead of resembling a flower in bloom, it appeared withered and dead.

## ***An Ancient Flower with a Much Older Past***

*In December of 2001, shortly after this travel journal was translated, a team of Canadian archaeologists linked to Serenia. They hoped that, by meeting with the Protectors serving at the monastery and examining the two Memory Chambers there, they might be able to determine how long Serenia's civilization has flourished.*



*Oral histories shared by the Protectors during that visit indicate that the fungal flower currently being used by the Serenians was placed into service some 2,000 years before Atrus or his family members visited. It supplanted the village's original Memory Chamber only after that much older flower had entered its maturation cycle, some 8,000 years into the fungus's development.*

*Based on these records, it seems safe to assume that Serenian civilization has existed for at least 10,000 years. That puts it on par with Earth's earliest permanent settlements, which now lie buried in the Mesopotamian region.*



*Examining this pole revealed a conversation between Anya and Yeesha.*

I stepped out onto a small balcony and examined a pole sticking up from the middle of it. Touching Yeesha's necklace allowed me to hear a conversation between Yeesha and Anya, in which Yeesha expressed her surprise that the Protectors needed to use this pole to send a signal every time they left the area to return to their village.

Leaving the balcony, I continued on the pathway as it ran past the old Memory Chamber, just in time to see Achenar climbing up from the Memory Chamber with a Serenian artifact in hand—the same one I saw him take in the vision I experienced earlier. He tried to explain his actions by saying that he was taking the artifact to frustrate Sirrus’s plan to kill Atrus. Before fleeing, Achenar insisted that I keep Atrus from coming to Serenia and told me to look for his journal, hidden in a stone pillar in the forest where two rivers meet.



*I surprised Achenar as much as he surprised me.*



*The broken bridge prevented pursuit, but the hidden red handle opened another avenue.*

I couldn’t follow Achenar due to the broken suspension bridge that separated us. However, while looking for a way to cross the chasm, I saw a red handle protruding from the bridge post. I pulled the handle and heard a soft scraping of stone on stone behind me.



*A hidden passage*

Pulling the handle had opened a narrow shaft behind me. I couldn’t see the bottom of it, but the ladder leading down seemed sturdy, so I descended.

## Fitting Site for a Confrontation

*In retrospect, it seems rather interesting that the location in which Achenar and the stranger first spoke to each other happened to be at the monastery's ceremonial site. This area has great significance in Serenian culture, as it is the first altar to be used during most funeral ceremonies.*

*When a Serenian dies, his or her corpse is carried to the monastery via balloon transport, which docks at the ceremonial site for a brief ritual. Next, a procession of villagers carries the corpse down the ceremonial alley and into the Memory Chamber. There, more Protectors step forth to receive it.*

*No doubt, if the stranger had known any of this before encountering Achenar that day, their interaction across the broken bridge would have felt even more unnerving.*



*Healthy and unhealthy roots merged in this room.*



*The pedestal where Achenar's artifact formerly rested]*

The ladder led down into a subterranean room where massive vines intertwined along the walls. Half of the vines in the room were healthy while the other half were dead and shriveled. The thought crossed my mind that they might be the roots of the two Memory Chambers.

Descending all the way to floor level, I examined the pedestal in the center of the room. Yeesha's necklace revealed that it was the former location of the artifact Achenar now possessed. The ropes I saw him cutting were attached to rocks on either side of the artifact, which didn't seem like a very good security system. Then again, maybe that's not what they were there for.



*The device seemed to direct sunlight, but why?*



*A crack in the wall of the room was a second way out.*

Near the pedestal was a swiveling device that seemed to be used to direct the sunlight that filtered in through slits in the wall behind it, but I couldn't fathom what it could be used for.

It didn't take me long to explore the entire artifact room, and the only other area of interest was a crack in the wall with all of the withered vines. I was able to slip through this crack and climb up the vines outside of it to reach the other side of the broken bridge—just as Achenar had.

### Old Memory Chamber



*I crossed this bridge and lost Achenar.*

Achenar had a decent head start, but I still hoped to catch up with him. I followed the path and crossed a small lowered drawbridge, figuring that Achenar must have lowered it in order to cross a stream. However, if he did go that way, he managed to lose me in the stone forest beyond it. I wound up back at my linking point before I gave up hope of finding him.





*I walked down these stairs near the drawbridge.*



*This platform held memories of SIRRUS and ACHENAR.*



*I raised the harvester by pushing the left lever and opened it by pushing the right one.*

Returning to the drawbridge, I descended a series of narrow stone steps and arrived at the base of the defunct Memory Chamber. The door at the base of the Memory Chamber was sealed (probably for safety's sake), but the harvester apparatus next to it seemed operational.

A platform to the left of the sealed door held the memory of a conversation between SIRRUS and ACHENAR, which I heard by touching Yeasha's necklace while exploring it. SIRRUS impressed upon his brother the importance of being discreet while bringing materials into this area. Despite the fact that the Protectors rarely visited it anymore, the brothers would still have to answer some tricky questions should they be caught. ACHENAR's grumbled response revealed that he planned on working at night, when the Protectors had already gone.

After hearing this conversation, I was more determined than ever to find a way into the Memory Chamber. If SIRRUS and ACHENAR were hiding anywhere on Serenia, this was the most likely location. However, the door was still locked, so I turned my attention to the harvester, raising it from the water with a push on the left lever in front of it and opening it with the right lever.



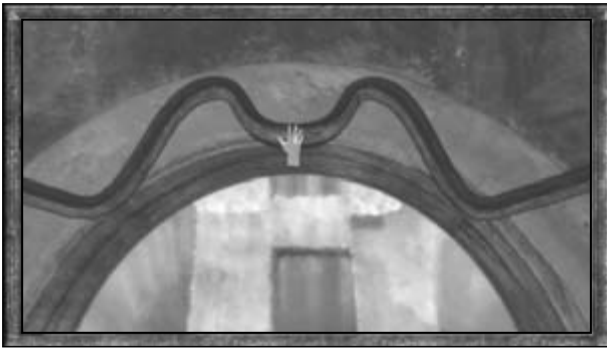

*I entered the harvester and descended by pulling the bar above the window.*

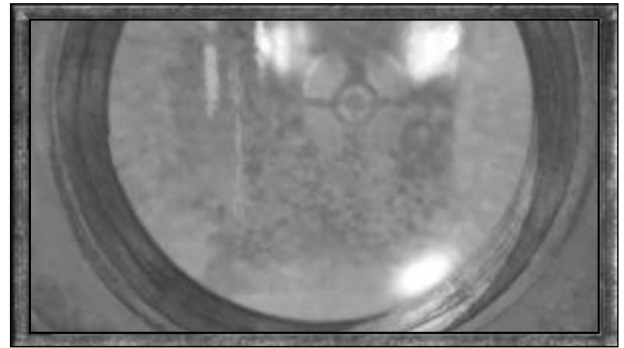

*Some kind of door?*

I stepped into the harvester and pulled the hatch shut behind me. Turning to face the window, I pulled down on the bar that ran above it, and the bathysphere began to sink into the water below.

As the harvester descended, I saw what looked like a second door to the old Memory Chamber below the surface of the water. So that's how the brothers came and went from their workshop all those years ago. It was so ingeniously hidden that apparently the Serenian Protectors hadn't found it in all that time.

I pulled down on the bar above the window again and pondered how to reach the submerged door. Opening the harvester was impossible when it was in the water, due to the weight of the water pushing down on the door. If only there was some way to drain the water.

That was it. The irrigation control device I had seen near the linking point was part of a system that diverted the flow of Serenia's waterways, and the tile map on the monastery pavilion showed the paths of the streams.

## Irrigation Devices

I began looking for the irrigation machines to see if I could find a way to divert the two streams of water that fed the pool under the harvester. Walking away from the old Memory Chamber, the first irrigation device I came to was just past the drawbridge. The spokes on one of its gears were



*This irrigation device was smashed—by Sirius?*

smashed, rendering it useless. It looked like intentional damage. I suspected SIRRUS might have had something to do with it, judging from his destruction of the new harvester. What was he trying to hide in that old Memory Chamber?

After a bit of observation, I found that the two streams that passed through this irrigation device could be shut off by two other irrigation devices. I backtracked to the area near my linking point and found the first of these two irrigation machines. Pushing the handle on the front of it all the way to the right cut off the flow of water from the left side of the machine.



*I returned to the irrigation device near the linking point and pushed the lever all the way to the right.*



*The second irrigation control machine*

From the wooden footbridge near that irrigation machine, I went left at the fork in the path. Continuing straight down that pathway brought me to the second irrigation machine.

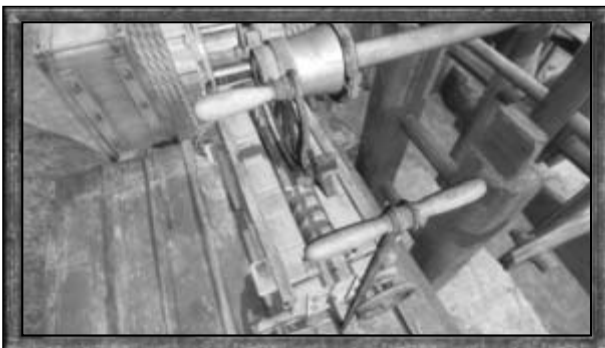

*I climbed the ladder and rolled the cart to the right*

I climbed up the ladder on the side of the machine and pulled the cart at the top of it to the right. A sprocket at the top-right side of it slotted perfectly into an extended dowel.



*I turned the half-wheel valve clockwise.*



*I pulled the lever on the front of the device.*

Stepping to the back of the cart, I turned the large half-wheel valve clockwise as far as it would go. I then stepped back around the cart and pushed it back to the left so that the sprocket released itself from the dowel.

I then climbed down from the ladder and walked to the front of the machine, where I pulled a lever, opening a sluice gate to the right and closing one to the left. When I returned to the broken irrigation machine, I found that I had successfully stopped the flow of water to it. That took care of one of the streams feeding the old Memory Chamber's harvester pool. Now I had to shut down the other one.

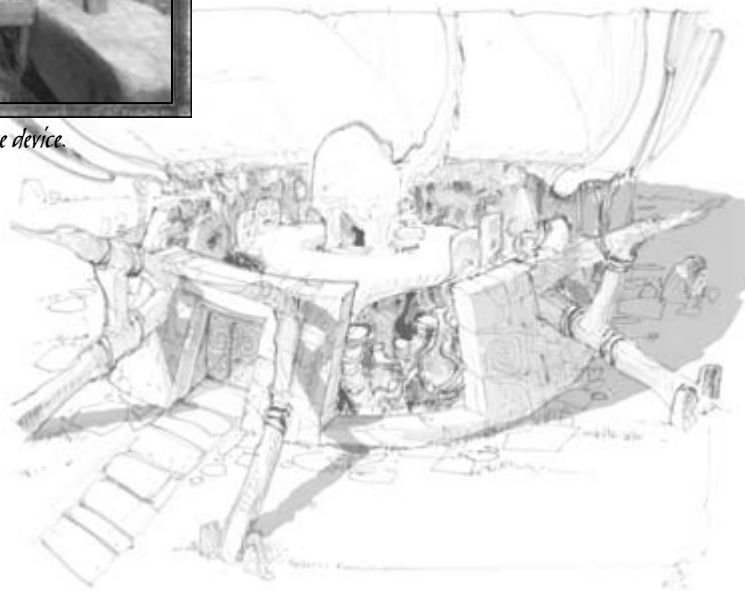

## Achenar's Journal

*During my exploration of the stone forest and study of the irrigation devices, I came across Achenar's journal. As he told me during our encounter near the artifact room, it was hidden in a stone pillar at a point where two rivers crossed. The second, more elaborate irrigation machine that I operated was visible beyond the pillar with the journal in it. The irrigation machine near my linking point was to the left, and the monastery was behind me. If any Protector was looking specifically for the journal, they would find it by searching at waist height for its wooden crate in the area around the more complex irrigation machine.*



*Yeessa's necklace revealed Achenar's reasons for hiding the journal. Although he was willing to work with Sirrus 20 years ago to get rid of Atrus and prevent him from learning of the havoc they had wreaked across his Ages, Achenar trusted his brother about as far as he could throw him.*

*The journal itself was chilling to read. I could virtually picture Achenar salivating at the prospect of removing Atrus's memories through the use of a "chair" in the old Memory Chamber (the same one I saw Yeessa strapped to in my earlier vision?). He also made reference to "using" Atrus's body after the memory transference, but for what he did not make clear. The journal also confirmed my suspicion that the hidden door under the old Memory Chamber led into the chamber, which the brothers were using for a workshop of sorts.*



## *Achenar's Journal (continued)*

*Reading the journal also filled in some gaps in my understanding, not just of what was going on in Serenia but of family struggles from 20 years ago. For instance, the brothers were responsible for luring Catherine to Riven in an attempt to lure Atrus to the prison in D'ni where I first met him. And no matter how closely Achenar worked with SIRRUS, he had absolutely no trust in him whatsoever. Ultimately, Achenar abandoned the plan when he suspected that SIRRUS was going to use the old Memory Chamber against him.*

*The artifact that I saw Achenar steal was a "life stone" that fed the fungus in the Memory Chamber and gave it the power to remove memories. Perhaps Achenar was trying to frustrate SIRRUS's efforts, for without that life stone, SIRRUS would be unable to use the old Memory Chamber against Atrus—in theory, anyway. I realized that I only had Achenar's word on this matter, but the fact that his story remained consistent over 20 years did lend some weight to his assertions.*

*On the whole, the journal was unequivocal evidence of just how twisted Achenar's mind was before his 20-year imprisonment. Why then did he send me out to find it? Could Atrus's hope of reforming his errant sons through their imprisonment have been realized in Achenar? Or was this simply an elaborate ruse devised by the brothers to lure me into their clutches?*



*The other stream was controlled by a fourth irrigation device in the ceremonial site.*

The second stream feeding the pool outside of the old Memory Chamber was controlled by an irrigation device in the ceremonial site, near the broken bridge where I'd met Achenar.



*Something wrapped around the wheel prevented me from moving it.*

When I examined the device more closely, I saw that there was something locking the control wheel—something hard as stone but somehow wrapped through the spokes of the wheel. No matter how I tried, I couldn't remove it to turn the wheel, which meant that I could not yet drain the old harvester pool and reach the secret door to the old Memory Chamber.



*Lush tropical wilderness—Haven?*

I touched Yeesha's necklace while examining the device and saw a vision of a lush tropical wilderness. It matched the description of the Haven Age that I had read about in one of Atrus's journals on Tomahna. Was this something Achenar had placed on the irrigation machine? If so, why?

There was obviously nowhere else for me to go in Serenia and nothing else I could do at the present time, so I returned to my linking point and used the Linking Book there to reach Tomahna.



## Tomahna, Part Four



### RETURN TO TOMAHNA

#### Sunroom

The Tomahna Linking Book in Serenia brought me to Atrus and Catherine's sunroom, a part of their home I had visited during earlier trips but not yet in this one.



*I linked back into the Tomahna sunroom.*



*A shawl on a bench contained a memory of Catherine holding Yeesha.*



*I closed the door to the left that led into Atrus's study.*



*A journal contained Atrus's ruminations on Serenia.*

I saw a shawl lying on one of the sunroom benches and examined it, touching Yeesha's necklace as I did. This triggered the vision of a happy memory—Catherine holding the baby Yeesha and bouncing her up and down on her knee while sitting in the sunroom. It steeled my resolve to find and rescue Yeesha as quickly as possible.

### Atrus's Study

I walked past the shawl and opened the closed door to Atrus's study, familiar to me from many visits over the years. Even without its master present, the room radiated Atrus's personality. Pictures of SIRRUS and Achenar sat on the opposite corner of the desk from a portrait of Catherine and Yeesha, evidence of Atrus's conflicting desires to free his sons and defend his wife and daughter.

A journal on the desk revealed Atrus's impressions of Serenia, and I found for the first time that Catherine had written the descriptive book for that Age. While maintaining his scientific skepticism, Atrus struggled to relate the mystic aspects of Serenian culture, including the supposed origin of the Memory Chamber.

The tears of a grieving mother awakened a flower that told her to place her son's body into its pistil. The flower promised to preserve the boy's memories so that the parents could visit him whenever they wished.

Atrus, of course, had a different perspective. The Memory Chamber was little more than a

massive fungus, its "visions" the result of some hallucinogenic property. In fact, Atrus surmised that the



fumes of each Memory Chamber grew more toxic as the plant reached maturation, explaining the Protectors' need to find a new Memory Chamber to replace the one they had locked up.

Still, despite his obvious disbelief in Serenia's mysticism, Atrus did not protest when Yeesha expressed an interest in learning more about it. Yeesha apparently took to dreaming like a fish to water and excelled in it. Even Atrus had to note that Yeesha had started to display an uncanny degree of insight, knowing details of her grandmother's death on an Age that Catherine had written—details Atrus had never revealed to her.



*The quill showed Atrus's letter to me.*



*Linking Book to Serenia*

My hand brushed Yeesha's necklace while I examined the quill pen next to the journal. I saw an image of the letter that Atrus sent me to bring me to Tomahna and heard him read it aloud before sending it.

Near the desk was a book on a pedestal. I opened it to find that it was a Linking Book to Serenia. That was going to make it easy to return there after scouring Haven for clues.

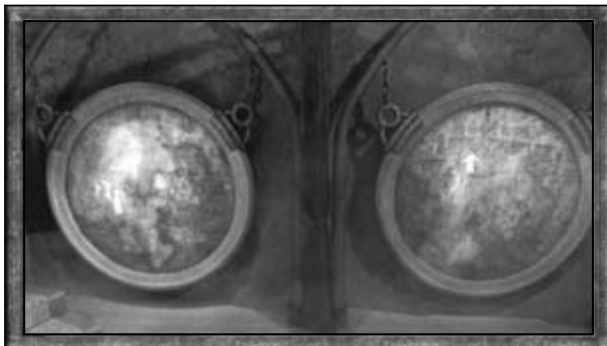

*Frescoes on the wall contained memories of the fire that consumed this room.*

I examined the frescoes hanging on the wall of the room and touched Yeesha's necklace as I did. The left one contained a painful memory of Saavedro's ambush on Tomahna 10 years ago, which left the study a charred cinder of its former self. The right one allowed me to hear Catherine's observation that Atrus reconstructed the study exactly as it had been before the fire, without redesigning it as he originally planned.

## Tomahna after the Fire

*The fire that was started in Tomahna 10 years before Yeesha's kidnapping deserves a brief mention here. Not because of the way it happened—those of you who have seen the stranger's "Exile Journal" should be familiar enough with those details. But rather, because of the effect it had on Tomahna's inhabitants.*

*Atrus had to postpone several trips he'd set up in order to supervise renovations.*

*Plans for safeguarding Tomahna became all consuming, and it was then that the idea of using security cameras first came to him. Catherine's journals indicate how much she hated this proposal, as it reminded her of being watched again on Riven. In the end, however, Atrus was able to persuade her.*

*By then, of course, both the fire and the misguided "intruder" who had started it seemed like distant memories to everyone.*

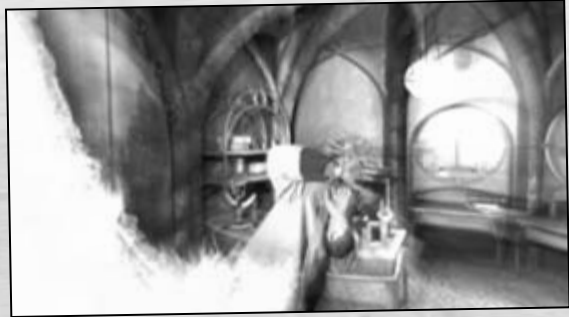

## Linking to Haven



*I went through the open doorway to Catherine's study.*

Having explored Atrus's study sufficiently, I returned to the sunroom and walked through the open right door, which led to a passage to Catherine's study. The door to the study was locked, but a quick spin of the star-shaped locking mechanism released it.



*I returned to Atrus and Catherine's bedroom.*

From Catherine's study, I retraced my steps to the elevator by turning left at the door and following the pathway through one of Catherine's gardens. Pulling the lever next to the elevator platform called the elevator to my position. Once inside of the elevator, I pulled the handle down to the third setting to reach Atrus and Catherine's bedroom.



*I rode the fireplace elevator down to the hidden linking chamber.*

From Atrus and Catherine's bedroom, I rode the fireplace elevator down to the hidden linking chamber, just as I had done prior to visiting Spire. Because I had not changed any of the settings for the fireplace puzzle, I did not have to reset it.

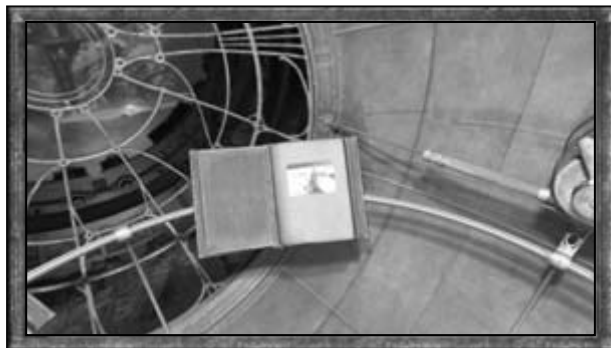

*I opened the hidden linking chamber and used the Haven Linking Book.*

Once I reached the hidden linking chamber, I pulled the lever to rotate the sphere containing the two Linking Books and entered it cautiously. There was no sign of Sirrus or Achenar. Pulling the lever inside of the sphere, I opened the two Linking Books, placed my hand on the pale blue one to my right, and linked to Achenar's former Prison Age, Haven.

# Haven

//



## ARRIVING IN HAVEN

---

I found Haven to be the exact opposite of Spire in nearly every way. Instead of a barren wasteland devoid of life, Haven's lush forests and grasslands teemed with plants and animals of every description.

Oddly enough, despite the fact that Atrus never intended for his sons to be imprisoned in the Prison Ages, the Ages they chose complemented their characters. Sirrus, who thrived on cold logic and analytical ruthlessness, linked into a world of unfeeling rock. His brother Achenar, known for his animal cunning and predatory viciousness, trapped himself on Haven, a primal jungle in which only the fittest survived.

### Linking Chamber

My linking point for Haven was a linking chamber that was almost identical to the one on Spire, which made sense. Since Atrus added the linking chambers 15 years after the brothers' imprisonments, it followed that he would try to add them simultaneously, which most likely involved copying the same block of text into each Age's descriptive book.

The linking chamber was a wreck. Shortly after I linked in, the *nara* stone wall separating the visitor area from the rest of the Prison Age crumbled further. I had only seen *nara* destroyed by one thing, and a quick glance at the rubble at my feet confirmed my suspicions. Remnants of Sirrus's frequency crystal bombs lay amid the rubble, circumstantial evidence that Sirrus had freed his brother. Touching Yeesha's necklace while examining the crystals replayed the linking chamber explosion in my mind's eye.



*A linking chamber similar to Spire's*

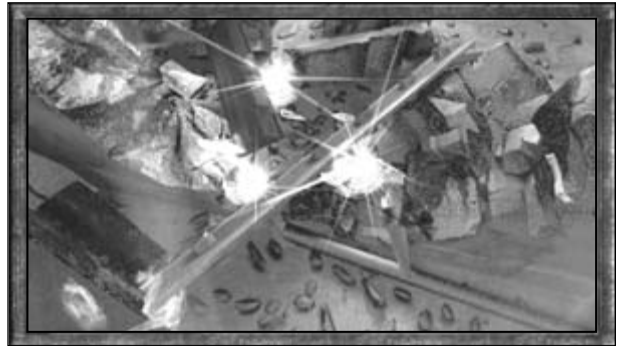

*Evidence of Sirrus's presence on Haven*



*A leather pouch held a memory of Yeesha fleeing.*

A leather pouch was tied to a small door in the wall that divided the two halves of the linking chamber. I held Yeesha's necklace while examining it and saw a vision of Yeesha running out of the linking chamber, fleeing from someone. I was unconscious for a long time after the initial explosion in Tomahna, and the first memory her necklace showed me after I had picked it up was of Yeesha dashing into the fireplace to escape her kidnapper. Did that mean this memory occurred before the one I saw in Serenia? Had she fled here first in order to escape pursuit?

## Yeesha's Dilemma

*Yeesha's decision to link to Haven to avoid pursuit offers interesting insight into the 10-year-old girl's personality. Her home had just been violently invaded by one brother. She had no idea how he had escaped, let alone whether her other brother was helping him. Why, then, would she risk linking to either Prison Age?*

*Yet evidence suggests that Yeesha did link to Haven and may have been hiding there for some time before either brother discovered her. The fact that she chose this option could easily be chalked up to a little girl's terror. But those who know Yeesha's courage believe it can also be explained as a calculated attempt to draw pursuit away from Tomahna—and from the stranger whose life she hoped to protect.*



*Tomahna Linking Book*

I was relieved to see that there was a Tomahna Linking Book here, just as there was in Spire. In retrospect, I realized that linking into Haven without bringing a Linking Book with me was a dangerous move and could have left me trapped in the Age had Sirrus or Achenar decided to take this Linking Book with them.



*Signal device*

Above the Linking Book and leather pouch was a signal device, bolted to the wall. I pushed the bottom handle into the device and heard it emit a long, low moan when I released it. This was probably used by Atrus and Catherine to announce their presence when they visited Achenar on Haven. Examining it while holding Yeesha's necklace allowed me to hear an echo of Achenar talking about having friends on Haven who accepted him. That contradicted what I'd read of

Haven in Atrus's journals; he said it was devoid of human life. Then again, Achenar also admitted in this vision that being trapped on Haven for so long had made him "a little bit crazy," so it was entirely possible that these "friends" of his were figments of his imagination.



*I examined an opening in the rock wall behind the linking chamber.*

Stepping out of the linking chamber, I examined an opening in the rock wall behind it and saw an intricate latticework of bamboo-like poles. I could not even begin to imagine what it was used for—some sort of support structure or a trap for a very large animal were my two best guesses. It was also entirely possible that this was Achenar's attempt at creating a work of art to brighten up Haven.

### To the Shipwreck

Returning to the exterior of the linking chamber, I saw a wrecked ship in the distance, standing vertically on its stern. That seemed as good a place as any to explore



*I decided to head toward the distant shipwreck.*

A scurrying crab caught my attention. I approached it to examine it more closely and saw something glinting on the ground below me. Pushing a small rock out of the way, I discovered another one of Sirrus's frequency crystal bombs. I held Yeesha's necklace as I examined it and saw a vision of Achenar fighting and overpowering Sirrus. As far as I knew, the only time Sirrus had ever visited Haven was when he bombed Achenar's linking chamber to free him, so this must have been a recent memory. Then Achenar was telling the truth when he said that he was trying to stop Sirrus.



*I found another crystal figurine outside of the linking chamber.*



*I climbed up the stairs leading through a passage in the stone wall.*



*Some sort of sea monster?*

There was another opening in the rock wall near the linking chamber, and this one had stairs leading up. Since this was the only avenue I could take, I entered it and climbed the stairs to the top.

At the top of the stairs was a crude painting of an enormous creature rising out of the water around the wrecked ship. If this was the sort of thing that Achenar had to deal with on Haven, it was a miracle he survived for 20 years. I saw another painting to the right of it, showing a humanoid figure (Achenar?) hunting aquatic creatures with a spear.



*I climbed another set of stairs for a breathtaking view of Haven*

I climbed another set of stone stairs behind me and received a breathtaking view of Haven's jungle for my trouble. I made a mental note of a man-made structure with a flapping flag in the distance—something to investigate later.







*I climbed down a rope to reach the beach.*



*The body of the beast in the paintings?*

There was nowhere to go from the vista point, so I walked back down the stairs and climbed down a rope near the first cave painting to reach the beach near the shipwreck. I continued walking along the beach.

The mammoth skeleton of some creature—a carnivorous predator judging from the sharp teeth and absence of molars—lay on the beach with spears sticking out of its bleached bones. Examining it with Yeesha's necklace allowed me to hear the sounds of a desperate struggle for survival between it and Achenar.



*A totem, marking the fight with the marine predator?*

Next to the carcass of the marine predator was an elaborately carved totem. Its proximity to the skeleton could not have been mere coincidence. Perhaps Achenar placed this here in commemoration of his victory over the creature? Yeesha's necklace supported this hypothesis, revealing the words Achenar spoke while placing the totem: "Intelligence, premeditation, stealth, patience...can't forget his patience." I made a note of the symbol in the center of the totem—a white square over a black diamond—and took a picture of it before moving on to the shipwreck itself.

## SHIPWRECK

I could not fathom how the huge ship had appeared in Haven. It was obviously not naturally occurring. Plus the entire island was ringed with a circle of rocks that should have prevented any ships from entering its lagoon. It looked as if it had literally fallen out of the sky. Atrus often referred to the unpredictable mysteries that came with Age-writing—this seemed to be one of them.

### Entering the Shipwreck

Passing by a trio of crabs feasting on a dead fish, I reached a wooden contraption at the foot of the wrecked ship. Examining the elaborate system of ropes and pulleys made me realize that it was a crudely constructed yet ingenious elevator that used a system of counterweights to raise and lower itself. Sirrus and Achenar might have been as different as night and day in many ways, but there could be no doubt that they shared a natural scientific genius.



*A crude yet ingenious elevator*

If I wanted to enter the shipwreck, I would have to figure out how to use the elevator. A winch and braking mechanism inside of the elevator wound and released a counterweight outside of the elevator, but if I did not have the proper balance of weight both inside and outside of the elevator, it would not operate properly.



*I placed two cannonballs in a box and pushed it into the elevator.*

It did not take long for me to learn how to operate the elevator. I began by pulling a small wooden box out of the elevator and rolling two of the four nearby iron cannonballs into it before pushing it back into the elevator.

**NOTE** THIS CANNONBALL BOX WAS NOT ESSENTIAL TO THE OPERATION OF THE ELEVATOR, BUT ITS PURPOSE BECAME CLEAR ONCE I RODE THE ELEVATOR UP.



*I rolled three cannonballs into the counterweight outside of the elevator.*



*The crank raised the counterweight, the slide catch released the counterweight, and the lever operated the elevator.*

Walking to the left side of the elevator's exterior, I rolled three cannonballs into the counterweight, which already had three cannonballs in it. Now the counterweight was heavy enough to lift my weight in the elevator.

Stepping into the elevator, I wound the crank inside of it to raise the counterweight. (I found during my experimentation that I could release the counterweight without raising the elevator by using the slide catch next to the crank.) A pull on the lever to the right of the crank started the elevator, balancing the weight of the elevator versus the counterweight.



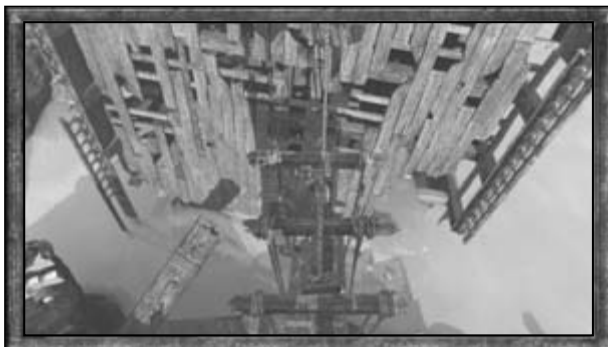

*There was a gap in the footbridge leading to the ship.*

I reached the footbridge that led to the ship, but there was a wide gap in the bridge. At first I thought that a section had simply fallen away, but then I saw that it was actually below my level, hanging from a pulley system. This was one of Achenar's security measures.

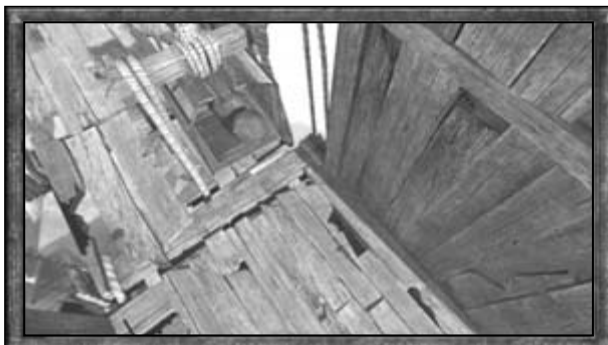

*I pushed the cannonball box out of the elevator to raise the footbridge.*

This was what the cannonball-filled box in the elevator was for. The counterweight for the footbridge was just outside of the elevator, and the footbridge weighed less than two cannonballs. Pushing the box onto the counterweight dropped the counterweight and raised the bridge into position. I could now cross into the ship.

I did not understand Achenar's desire for such an elaborate security system, but further evidence of his defensive mechanisms was visible from the footbridge. He had actually aimed one of the ship's cannons at the linking chamber. Seeing the linking chamber suddenly appear one day after 15 years of living in this wilderness must have awoken a primal fear in Achenar.



*Achenar had pointed a cannon at the linking chamber.*

### Achenar's Study

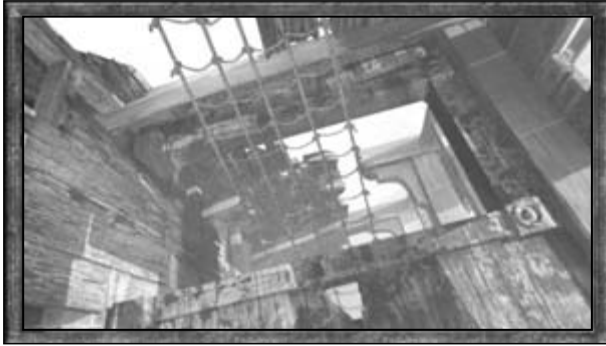

*Used a net of rigging to reach the bottom level of the ship.*

I decided to investigate the ship from the bottom up. From the end of the footbridge, I turned right and used a net of rigging to reach the level below me (which I eventually discovered was the lowest level of the ship that the paranoid Achenar would allow himself to live in).



*I found this on Achenar's desk—prints of animals next to their food?*

This brought me to a small study with a desk at the end of it. Scraps of paper blew around the room, but one seemingly important sheet was secured to the desk. It illustrated pairs of animal prints with objects, which I thought might be the foods eaten by the animals. A three-fingered primate paw print appeared next to a fruit, and bird-like talon prints were placed next to insects. It seemed important to Achenar, so I took a second to snap a photograph of it for future reference.



*A stuffed and mounted bird-like creature*

Above the desk was a stuffed and mounted bird-like creature. It looked like the ones I had seen flying around outside the ship, a cross between a lizard and a seagull. Touching Yeesha's necklace while examining the creature revealed that Achenar had killed it for stealing from him. His tone was a chilling reflection of his slipping sanity and his cruel nature.

Achenar's workbench sat around the corner from his desk. While examining it, I nearly lost a finger to a primed and active leg trap he had left on it. An atomizer on the right side of the desk emitted a green mist that caused me to feel a bit lightheaded when I accidentally inhaled some of it. Examining the desk in detail with Yeesha's necklace brought the echo of an angry Achenar to my ears. Apparently, a creature he had been hunting had turned the tables on him and injured him somehow, and Achenar had vowed vengeance—not just on the creature, but on every one of its kind. Judging from the taxidermic treatment that the thieving bird had received in the previous room, I didn't doubt that Achenar had done his level best to keep his word.

## Achenar's Bedroom

There was nothing else to see on this level of the ship, so I climbed back up the rope net to return to the footbridge level. From there, I ascended a ladder to reach the next level of the ship.

As soon as I reached the top of the ladder, a large avian animal swooped in and landed in front of me. At first, I was too shocked to move, but the creature just sat and looked at me while eating a fish, appearing entirely unconcerned.

I took the opportunity to get a good look at the beast. It was the same species of creature as the one Achenar had killed and mounted in his study for stealing from him. I also made a note of the size and shape of its feet. They looked as if they would have made the footprints that were paired with the fish on the sheet of parchment I had discovered on Achenar's desk.



*Achenar's workbench*

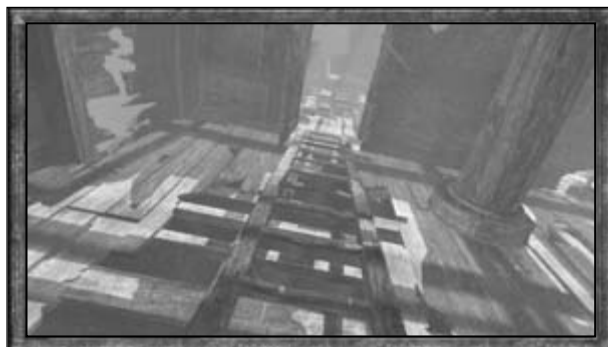

*I climbed up the ladder to the next level.*



*A huge avian beast, like the stuffed one in Achenar's study*

When I reached forward to touch the creature, it flew away. I walked to the end of the deck and saw a collection of fish carcasses; apparently this was a popular eating spot. To my right was another rope and pulley system, similar to the one in the elevator. I wound the crank, and a sail unfurled to the left, revealing a map of the island. Each area seemed to be labeled with an illustration of its dominant creature. I photographed the map before moving on.

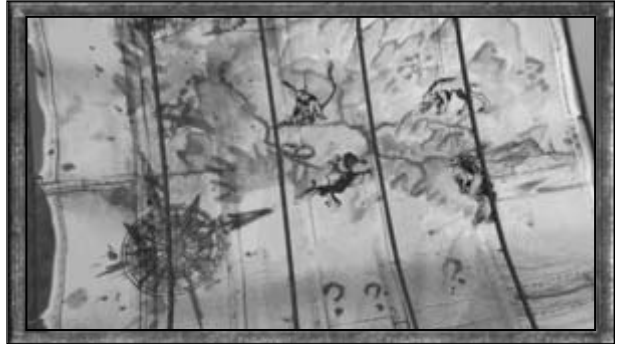

*A map on a sail*



*I entered a small passageway to Achenar's bedroom.*

The counterweight for the map blocked my path, so I flicked the slide catch next to the crank to fold the map back up and raise the counterweight. This allowed me to enter a small opening that led into Achenar's bedroom.



*Golden treasure lay scattered around a smashed chest.*

Gold coins and other valuable treasures lay in a scattered heap on the other side of the entrance to the bedroom. Using Yeesha's necklace to examine them, I saw a vision of Achenar rummaging through the ship in a futile search for the Linking Book that would let him leave Haven.



*Achenar's journal was on a bed that had not seen recent use.*

I approached the bed at the end of the room and noted its dilapidated condition. It seemed as if Achenar had not slept here recently, possibly not in years. What caused Achenar to leave the ship behind? And why did he leave a journal lying here?

I opened the journal and started reading. It began during the earliest days of Achenar's imprisonment on Haven. Strangely, it seemed as if it took Achenar a while to realize that he was trapped in the Age. The first entries recount his delight at finding the ship's treasure and the abundance of animals he could hunt.

**NOTE** SEVERAL PAGES OF THE JOURNAL WERE FADED, BUT TOUCHING YEESHA'S NECKLACE WHILE I READ THEM ALLOWED ME TO HEAR THE MISSING PARTS SPOKEN IN ACHENAR'S VOICE.



Achenar paid special attention to Haven's fauna, sketching out the animals in detail and giving them names. A bipedal herbivore with cloven hooves was a "zeftyr," and a quadrupedal predator that resembled a cross between a crocodile and a panther was dubbed a "camoudile." "Mangrees" were large-eared, furry primates that ate fruit, and the fish-eating birds around the ship were "karnaks." The mangree primates seemed to interest Achenar most. His first encounter with them started when one of them threw a piece of fruit at him. A shriek from the fruit thrower sent a signal to all of the primates to flee.

It was after this mangree encounter that Achenar first realized that there was no Linking Book on the island. His descent into mental instability was sudden and dramatic. Cursing his father, he began constructing temporary living quarters in the ship and obsessing about protecting his territory. He also began to hunt anything and everything on the island, using leg traps to snare the fish-hunting karnaks and planning to construct a hunting post to kill mangrees.

Achenar was distracted from his rage over his imprisonment by the sight of a mammoth beast in the lagoon around the ship. His writing took on a frantic tone, expressing remarkable admiration for the creature and a vow to successfully hunt and kill it. Like Sirrus with his dedication to finding his father's Linking Book on Spire, Achenar had found a purpose for living on Haven.



### *The Price of Adventure*

*Experts in criminal psychology have often theorized that it was the image of the shipwreck on Haven that lured Achenar to check out that Age first, rather than linking to Spire. The man's original forays into sadistic gratification had occurred under the tutelage of Black Ship pirates—no doubt, the image of a shipwreck would have stirred up titillating memories.*



*Regardless of why he linked there, the challenge of hunting down and brutally slaying Haven's wildlife quickly filled up his days. The thrill Achenar experienced during his hunting escapades was so strong that it actually prevented him from realizing he was trapped for several weeks. When he finally did make the connection, sheer panic set in.*

*According to the experts, Achenar fled this panic the only way he knew how, by descending ever deeper into brutality. The first five years of Achenar's confinement read as a textbook example of how savagery and bloodlust can send one spiraling into dementia.*



*I returned to the elevator and moved the slide catch to go back to the beach.*

After reading the journal, I was satisfied that I had explored every part of the ship that I could reach. Leaving Achenar's bedroom, I climbed back down the ladder and crossed the footbridge to the elevator. Moving the slide catch to the right released the counterweight and sent the elevator back down to the beach. From there, I backtracked along the beach and up the rope that brought me to the area with the cave paintings, which I now understood to be documents of Achenar's struggle with the sea monster.



*A supply depot with more cave paintings*



*I approached the "tent" to get a better view of the paintings, and a zeftyr leapt out.*

From the top of the rope, I followed the cave paintings straight to an open area piled high with crates. This seemed to be some sort of supply depot or storage area. Cave paintings decorated the nearby rock walls.

When I approached the cave paintings to get a better view of them, the tent (or what I assumed was a tent) in front of me rustled, and a startled zeftyr charged out of it and right toward me. As I tumbled to avoid the zeftyr, I must have been caught by a sudden gust of wind that picked up the canvas "tent," which I realized was actually a parasail.



*I glided along with the parasail over the top of the jungle.*

I was carried along, tangled in the canvas parasail, until I crashed to the ground somewhere in the jungle. For the second time since I answered Atrus's letter, I felt a blow to my head and lost consciousness on the jungle floor. The last thought I remember was: *How am I going to get back to the Tomahna Linking Book?*

### JUNGLE



*I awoke to see a mangree staring down at me.*

When I woke up, the first thing I saw was an inquisitive mangree staring down at me. In the distance, I heard the three-tone cry of another mangree—a long, high-pitched tone, a short, low tone, and another long, high-pitched tone. The mangree in front of me perked up its ears and fled not more than a second before a carnivorous camoudile leapt out of the brush at it. I was too stunned to defend myself, but fortunately the camoudile was in search of easier game. Perhaps Achenar's hunting had taught these beasts that humans were not to be trifled with.



*The parasail in tatters above me*

The parasail hung from a tree branch above me in tatters. Examining it with Yeesha's necklace allowed me to relive the wild flight and the mangree warning shriek.

I looked down at my feet and saw animal tracks. Comparing them to the parchment I found in Achenar's study confirmed that these were the prints of the camoudile that leapt over me at the mangree.



*The camoudile's footprints*



*I walked in the direction that the camoudile prints pointed to enter the mangree forest.*

As I walked down the path, I turned to my right to follow the sound of chattering mangrees and saw two of them playing atop another totem in the distance, similar to the totem I saw on the beach near the skeleton of the sea monster.

I kept walking down the path, frequently catching glimpses of mangrees dashing through the brush. One leapt down to a tree branch in front of me and uttered the warning cry I heard shortly after waking up.



*Mangrees playing on another totem*

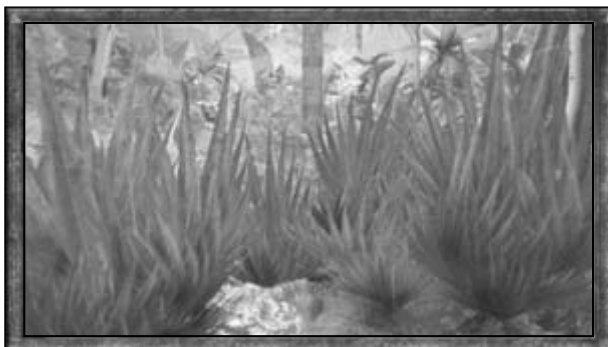

*The path ended at some bushes, which I pushed out of the way.*

### Mangree Forest

I stepped onto the narrow path that the camoudile prints pointed toward and entered what I would come to call the mangree forest, due to the number of primates I saw there.

This was obviously not a path that Achenar had used recently, as the end of it was overgrown with orange-leaved bushes. I pushed them out of the way and continued toward a hunting post beyond them.



*Achenar's hunting post*

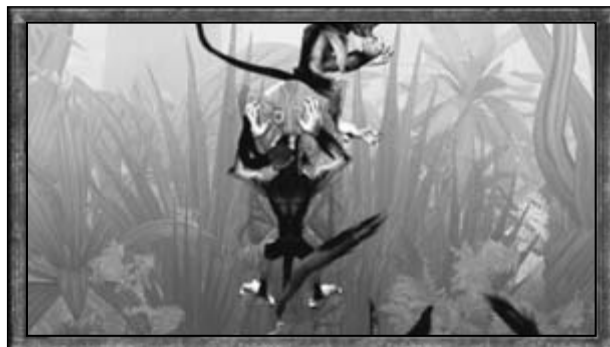

*Mangrees playing on a totem in the distance*

I climbed up the hunting post's rope ladder to get a better view of my surroundings. The hunting post was unsurprisingly filled with weapons—spears, crossbows, and other implements of destruction. A crude etching of a mangree head on the wall had 32 score marks next to it.

The first thing that drew my attention was a clear view of three mangrees playing on the totem that I'd seen earlier. I leaned in closer to get a better look at them and confirmed that the totem was similar to the one I'd seen on the beach, but I couldn't get a good view of it because the mangrees were clinging to it.



*Cranks produced low, middle, and high tones (from left to right).*



*I played the warning call to scare off the mangrees.*

I wasn't close enough to the mangrees to scare them away, but I did want a better view of that totem. I turned my attention to a device on the side of the hunting post near me. Three cranks produced different tones—from left to right, they were low, middle, and high.

The only conceivable reason for Achenar to put this device on the hunting post was to be used as an animal lure. Listening to the tones that the device produced reminded me of the mangree warning call that I





heard earlier. I decided to try and recreate it and eventually succeeded in doing so by turning the right crank for two revolutions, then quickly turning the left crank for one revolution, and finally turning the right crank for another two revolutions.

The mangrees scattered, and I could now observe the totem in clearer detail. Like the first totem, it had a diamond-shaped design in the center of it, although this one was slightly different. I wondered if Achenar meant to associate its four-petaled floral design with mangrees, and if the white square from the first totem was representative of the sea monster.

I examined the crossbow near my feet and found that Yeesha's necklace revealed the memory of Achenar hunting mangrees with it. It was a miracle that there were any living creatures left on the island at all after 20 years of Achenar's hunting.

As I turned to leave the hunting post, I realized that there was a rolled-up parchment over the rope ladder. I unfurled it to see a chart that featured animal prints arranged in a pyramid. It was some sort of food chain hierarchy, with the five-fingered hand print (representing the sea monster, which was drawn with five-fingered claws) at the top of it and the cloven hoof of the herbivorous zeftyr at the bottom. I translated it as:

## FOOD CHAIN HIERARCHY TRANSLATION

Print	Creature	Diet	Rank <sup>1</sup>
	Sea monster	Carnivorous	1
	Camoudile	Carnivorous	2
	Mangree	Omnivorous	3
	Karnak	Omnivorous	4
	Zeftyr	Herbivorous	5



*The crossbow held the memory of hunting mangrees*

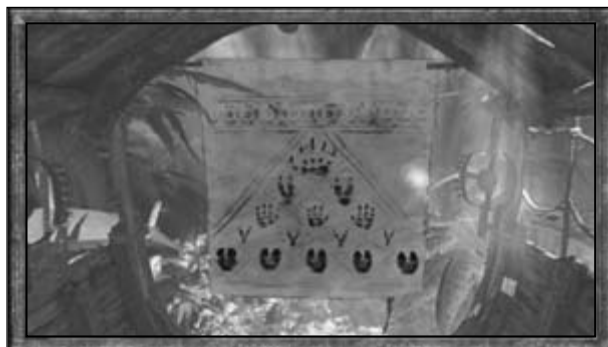

*I unfurled a chart from the entrance to the hunting post.*

1. A creature's rank in the food chain pyramid is indicated by the number of prints that appear on the chart. Lower ranks represent creatures nearer the top of the pyramid, such as carnivores and predators. Higher ranks represent creatures that are hunted more than they hunt, such as herbivores.



*I returned to the parasail wreckage*

There was nothing more to see in the hunting post, and the vegetation around the mangree forest was far too thick for me to penetrate with anything less than a sharp machete. I also reasoned that if Achenar, Yeesha, or anyone else was in Haven, they would probably be in one of the structures that Achenar had built. I rolled the chart back up, climbed down from the hunting post, and returned to the wreckage of the parasail.

### Camoudile Grasslands



*A trap on the path, fortunately closed*

I took a step forward, away from the wreckage of the parasail, and looked down to find a leg trap in the path. Fortunately, it was closed, or I might have lost a foot to it. A vision seen with Yeesha's necklace implied that it was used to trap zeftyrs.

The path split just ahead of the trap. The left-hand path extended into a grassy region, where I saw two zeftyrs grazing. I decided to try and approach them, but they ran off as soon as I did.



*I took the left path to the camoudile grasslands.*





*A camoudile pounced on a zesty.*

As I crept quietly by the distracted camoudile, I was surprised by a karnak, which swooped down near me and landed atop a log overlooking the dining camoudile. An axe was stuck in the log. When I examined it with Yeesha's necklace, I saw a vision of Achenar using the axe to chop down the tree that the log used to be.



*I crept past the camoudile and saw an axe buried in a log.*



*I continued following the path to the beach*



*The plant's pollen knocked out the camoudile.*

I continued following the path toward the water in the distance and arrived at a pair of the strangest plants I had ever seen. As I admired them, a camoudile crept through the grass behind them, stalking me

My heart raced as I looked in vain for a way to escape the stalking camoudile. It was faster and stronger than I, and I had no weapon or protective clothing. As the camoudile slunk closer, it brushed up against the



plant, which released a cloud of green pollen—the same substance in the atomizer on Achenar's workbench. The camoudile attempted a half-hearted lunge, but it was unconscious before it could reach me.

Although I didn't want to remain in the area any longer than was necessary, I did examine the plant with Yeesha's necklace. I found that Achenar did in fact coat his spears with the plant's poison when hunting camoudiles, increasing the weapons' effectiveness.



*I followed a path to the left and saw another totem.*

I didn't want to risk being around the camoudile when it woke up, so I backtracked through the grassy path I'd just come through. On the way back, I noticed a very faint trail to the right and followed it around a giant boulder to find a third totem. This totem was obviously meant to represent camoudiles, and the symbol in the center of it was three dark triangles with a single light triangle overlaid on top of it. I took a picture and then examined the totem with Yeesha's necklace and heard Achenar say the words, "strength, dexterity, courage" as he placed the totem.

Not wanting to push my luck with the camoudiles any further, I backtracked all the way to the main forest path I had left to enter the grasslands. As I did, I saw that the karnak that swooped in to land on the axe log now ate from the abandoned carcass of the camoudile's zeftyr.

## Karnak Cove

From the entrance to the camoudile grasslands, I turned left and walked uphill along the main forest path. Two mangrees and a pursuing camoudile dashed across it in front of me.



*Two mangrees and a camoudile crossed my path.*



*I chose to continue along the path under the log rather than enter a swamp.*

The path forked just past the mangrees and camoudile. The left path led into a swamp while the forest path to the right snaked under a log. I decided to stay in the forest, having no particular desire to enter the swamp if I didn't need to.



*A locked gate to some sort of cove*



*Karnak cove locking mechanism*

The path led to a locked gate. There seemed to be some sort of cove beyond it, but I could not see very much through the wooden bars. The locking mechanism was to the left of the gate.

I examined the locking mechanism more closely, sliding its stone lid up to reveal three rows of sliders and notches, with two small wooden hammers between the rows. Examining the lock with Yeesha's necklace allowed me to hear Achenar cursing the Karnaks and challenging them to try to get past the gate.

After manipulating the gate lock for some time, I realized that there were limitations on how the parts of the mechanism could move. The only way to move the hammers was to flip them so that they rested in a slider, and the only way to move the sliders was if a hammer rested in them.

The goal was to move the hammers and sliders so that the hammers rested outside of the sliders and in the notches marked with white dots (representing the lock's tumblers).

This is how I unlocked the gate, starting from its initial state:

1. *Flipped the upper hammer down.*
2. *Pushed the middle slider to the left two notches.*
3. *Flipped the upper hammer up.*
4. *Pushed the upper slider to the right one notch.*
5. *Flipped the lower hammer up.*
6. *Pushed the middle slider to the right three notches.*
7. *Flipped the lower hammer down.*
8. *Pushed the lower slider to the left one notch.*
9. *Flipped the upper hammer down.*
10. *Pushed the middle slider to the left two notches.*
11. *Flipped the upper hammer up.*
12. *Pushed the upper slider to the right two notches.*
13. *Flipped the upper hammer down.*
14. *Pushed the middle slider to the left one notch.*
15. *Flipped both the upper and lower hammers up.*
16. *Pushed the middle slider to the right two notches.*
17. *Flipped the lower hammer down.*
18. *Pushed the lower slider to the left two notches.*
19. *Flipped the lower hammer up.*
20. *Pushed the middle slider to the right one notch.*
21. *Flipped the lower hammer down.*



## The Door That Leads to Nowhere

*Of all the structures Achenar built during his 20-year imprisonment on Haven, the gate leading to karnak cove remains the most bemusing. It appears as if Achenar installed it to keep the karnaks from pilfering his supplies. Yet even the most cursory exploration of his Prison Age reveals just how useless such a structure would be.*



*Psychiatrists point to this gate as evidence for how severe Achenar's disassociation from reality was during the first five years of his imprisonment. "Obviously," writes Dr. M. N. Hartley, a specialist who has studied Achenar's journals extensively, "the man convinced himself that Haven's animals were human, and that he was the king they must serve. In such an advanced state of dementia, it would be easy for him to ignore the fact that karnaks can fly."*



*Karnak cove*

With the gate open, I walked through the doorway and into the karnak cove. Several of the beasts sunned themselves on rocks or dove into the water. I saw a couple of man-made structures in the distance, including the building with the flag that I had seen from the area near my linking point.

Touching Yeesha's necklace as I looked out at the structures showed the cove as it looked originally. During the vision, Achenar tried to reassure himself that the construction would not be so difficult once he managed to set the foundation. He seemed very tired of living in the wrecked ship.



*The fourth totem represented karnaks.*

As I turned to go, I saw the fourth totem behind an overgrown patch of brush. If I hadn't been paying attention, I would certainly have missed it. The totem was in the shape of a karnak, and an hourglass-shaped symbol adorned the center of it. When I touched Yeesha's necklace, I heard the call of a karnak. I snapped a photograph of the totem and returned to the main forest path.

### Zeftyr Swamp



*I entered zeftyr swamp by crossing the planks.*

From the entrance to the karnak cove, I turned left and followed the forest path back to the entrance to the swamp (which I would come to call the zeftyr swamp, for obvious reasons). I had found four totems thus far, and unless I missed my guess, there was at least one more to represent the zeftyr. This seemed like the best place to look for it.



*Zeftyr footprints on the rock*

As I traversed the mossy rocks and creaking planks, I came to a boulder with zeftyr prints on it. I photographed the prints and compared them with the ones on the sheet of parchment in Achenar's study. Sure enough, it showed the cloven hoofprint of the herbivorous zeftyr next to a sketch of a leafy plant.



*I took the left path at the fork to reach the totem.*



*Zeftyr totem symbol*

When the path forked, I followed the left branch, as I saw that it led directly to the totem. Several zeftyr grazed near it.

The symbol on the zeftyr totem looked like a black “S” on its side, enclosed within a white diamond. Touching Yeesha’s necklace as I examined it, I heard the words Achenar spoke as he planted the totem pole in the swamp: “Gracious, noble, cautious—stupid. Stupidity can be a virtue, can’t it?” I made sure to take a photograph of the symbol, then I returned to the fork in the swamp path.



*The left path led to the structures I saw from the karnak cove.*

I turned left at the fork in the path and saw that it led to the structures I had seen from my vantage point at the karnak cove. If Achenar had moved his living quarters to this lake house, this was my best bet for finding him or Yeesha.

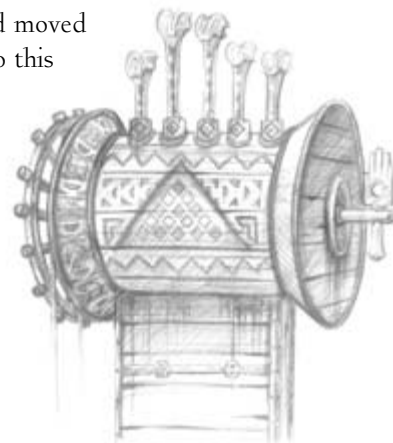



*This was a pretty clear sign that Achenar was not accepting visitors.*

### Lake House

I climbed the wooden stairs to reach the pathway to Achenar's lake house, only to find its drawbridge raised. And as if that weren't a clear enough sign that Achenar didn't want any company, the drawbridge was also in the shape of a giant hand, with the palm facing out.



*Drawbridge mechanism*





The mechanism that controlled the operation of the drawbridge was covered by a sturdy wooden box, which I opened by following the ropes above it over to a pulley to my right. I pulled down on the rope handle to lift the box off of the locking mechanism and examined it.

To lower the drawbridge, I had to enter the right combination of symbols into the mechanism by lifting up on the five bones that lined the top of it. The tough bit was figuring out which symbols went where. Obviously, the puzzle had something to do with the totems, as they shared the same

symbols as the locking mechanism. But where else had I seen five of anything displayed in something belonging to Achenar?

The etching of a pyramid on the mechanism was the clue I needed. The key to this lock was hidden in the pyramid food chain diagram Achenar had drawn. The number of prints that a creature had on the chart represented the position (from the left) of that animal's symbol on the drawbridge lock.

## DRAWBRIDGE COMBINATION CLUES

POSITION	CREATURE	SYMBOL
1	Sea monster	
2	Camoudile	
3	Mangree	
4	Karnak	
5	Zeftyr	

With the combination set properly, I spun the wheel on the left side of the locking mechanism, and the complex apparatus that controlled the drawbridge creaked into action, lowering the bridge and allowing me to cross it and reach the lake house.

The only tricky part was entering the zeftyr symbol on the fourth position, as the viewing scope that showed the symbol for that position was shattered. However, the order of symbols was the same on each bone: karnak, camoudile, sea monster, mangree, and zeftyr. Since the zeftyr symbol (for the fourth position) was only one notch higher on the bone than the mangree symbol (for the fifth position), I set the other four bones and then simply raised the fourth bone one notch higher than the fifth one.



*I dropped the drawbridge, making the lake house accessible.*

## A Monumental Task, Even for a Son of Atrus

*Many have marveled at the amount of effort it must have taken Achenar to build his famous “lake house.” For starters, he needed to assemble building materials—and although much of the cabin’s upper pieces could be scavenged out of the wreck, a great deal of additional hardwood needed to be found.*





### ***A Monumental Task, Even for a Son of Atrus*** (continued)

*Achenar had no choice but to harvest this wood from the jungle since the bulk of the lake house's foundations were to sit underwater. Trees growing near the savanna would have been sturdiest; even today, one can find evidence of extensive deforestation in that area. Yet obtaining the wood was merely the first challenge.*

*Once he had his foundation's materials in hand, Achenar had to install them under the water. Handmade diving equipment found amid the prisoner's things shows how he must have accomplished this but gives no indication of how long the process took. Today, only one thing can be said with any certainty: In devising his plan and seeing it through to completion, for the first time in his life Achenar resembled his father.*



*The lake house*



*Achenar's bed, with his second journal on it*

The front door of Achenar's lake house had seen better days—was this the result of poor maintenance or physical damage? I cautiously pushed through it and entered the lake house.

I found Achenar's second journal on his bed and read it. Achenar had apparently gone a long time without writing. He started off by recounting a visit to the shipwreck and the bones of the giant sea creature—the first visit he had taken there in quite some time. From the way he wrote about the sea creature (which I learned was called a “cerpatee”), it seemed as if he wished that it still lived and the hunt continued. The totems that I saw arose from his desire to create some sort of tribute to the creature, and to the others he had hunted.

Achenar also appeared to go through a period of genuine remorse for the actions he and his brother took against the inhabitants of the

Ages they enslaved. As his ink supply dwindled, he was forced to make more according to the technique showed to him by the people of the Channelwood Age, which he and Sirrus had all but destroyed.

While exploring the southern jungle, he noted that the mangrees in it did not flee from him, which he attributed to the fact that he had never hunted in that area of Haven. Achenar decided to build another post in the southern jungle and study the mangrees there. After doing so, he made the shocking discovery that the mangrees had a crude spoken language and that they had named him.

Whether it was the realization that the mangrees were thinking creatures, or the recollections of the people of Channelwood, or the grief over his slaughter of the last cerpatee, I could not say. But it seemed as if Achenar was starting to repent for the life he had led, both before his imprisonment and during his first few years on Haven. Small wonder that Sirrus, still obsessed with killing Atrus, did not find a willing partner in Achenar when he freed him.

### ***Seeds of Redemption?***

*Not much has been written about Achenar's three-year "war" against the cerpatees. That, in itself, seems odd—as many believe it was this struggle that first gave the stranded prisoner something to live for. Capturing the mate, killing all their offspring, and ultimately defeating the male must have been a monumental endeavor—especially given the severity of Achenar's madness at that time.*



*Evidence shows that the man wasted no time following up this achievement with an even more impossible task: designing and constructing his lake house. Yet many believe completing this task was not at all what Achenar expected. Having no real challenges left to pursue once he'd finished construction, Achenar was soon forced to reexamine his situation. Given the already fragile state of his mind, to what new depths might he have plummeted if nothing else had occurred to cause him to change?*



*Achenar's shirt*

Next to the journal was a shirt woven for Achenar by his mother. When I held Yeessa's necklace and examined it, I heard Achenar crying out in agony over the memories of the people he had killed.



*I opened a chest to find this sketch and notation.*

I opened the chest next to the bed and found a sketch pinned to the inside of the lid. Below the face of a mangree was a grid of six boxes. Each column had a sketch of one of the three-tone generators I had seen in Achenar's hunting post in the mangree forest. I wasn't sure, but I believed that this was the *name* of the illustrated mangree, represented by the tones that composed it.



*I found another sketch rolled up on the desk*

I found a second mangree sketch rolled up on Achenar's desk. I unrolled it and saw that it seemed to be of an elder mangree, judging from its bushy white facial hair. Like the first mangree, its name was written in tonal notation below the sketch of its face.



*I climbed to the top level.*

I found a sketchbook lying next to a telescope and opened it. It featured sketches of creatures with marks beneath them. Upon touching Yeesha's necklace, I discovered that the marks represented population figures, and that Achenar was trying to repopulate Haven's species after nearly hunting them to extinction.

I found a third mangree sketch on the table near Achenar's inks. Examining the inks while holding Yeesha's necklace allowed me to hear the memory of Achenar's comments on making ink according to the Channelwood method.



*I opened a sketchbook next to the telescope.*



*Another mangree sketch*

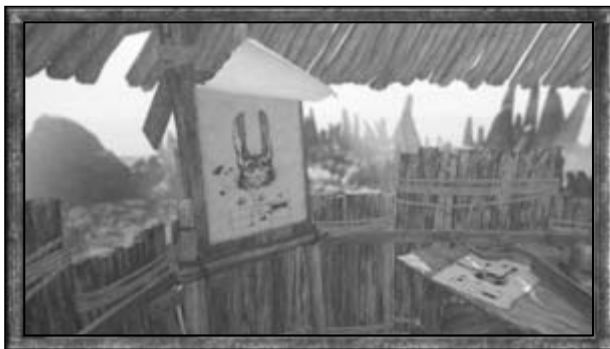

*I found a fourth mangree illustration under the painting on the easel.*



*I crossed the footbridge to reach the mangree playground.*

I followed the wooden footbridge to the end and saw that the path forked below me. However, since a camoudile snapped its jaws at me from the start of the right-hand path, the left path (which put a stone barrier between me and the camoudile) was the only option.

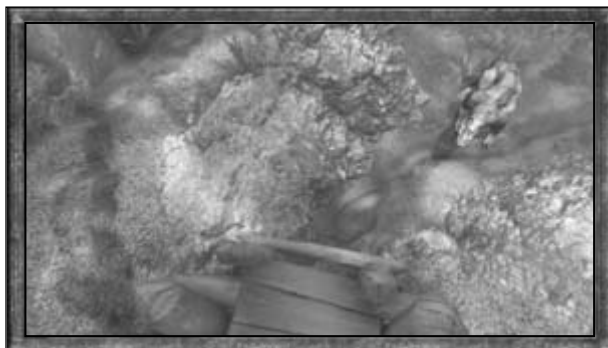

*The path split at the end of the footbridge, but there was only one way to go.*

A fourth mangree sketch, with notation, was hidden under a surprisingly good watercolor painting of the view from the top of the house. Apparently Achenar had gone from capturing wildlife with leg traps to capturing it with inks and paints.

To say that I was stunned by the evidence of the lake house would be an understatement. I believed that Achenar was on the side of the angels; it was now just a matter of finding him and Yeesha and stopping Sirrus from carrying out his patricidal plan. I still had not yet seen anything that would help me operate that final irrigation machine in Serenia, however, so I left the lake house and kept exploring Haven.

### Mangree Playground

I exited the lake house and turned left to follow the footbridge as it stretched into an area I dubbed the mangree playground. I followed the wooden footbridge through the lush forest.



*Achenar's observation post*



*'Attack!'*

I found Achenar's observation post at the end of the pathway and climbed up its rope ladder for a better view of the rest of the mangree playground. The four mangrees in the playground scurried up into the five elevated nests at the approach of the camoudile (one nest was empty). I had to get rid of that camoudile somehow if I was to continue exploring the area, and I didn't have time for it to tire of the hunt.

There was a sound device attached to the post, just as there had been in the hunting post. On the wall behind me hung a sketch of a mangree throwing an object, with a three-tone notation below it—the command for “attack” in mangree-ese, apparently.

Achenar had certainly studied his mangrees. I found through experimentation with the sound device that the four mangrees in the playground were the ones he had deciphered the names of. Furthermore, I found that “calling” a mangree's name with the sound device would cause it to

leave its nest and run across a vine to the empty nest, luring the camoudile to its new nest. There were only two exceptions to this rule:

- 1. If the camoudile was directly below the mangree's nest, it would not leave its nest.*
- 2. If the mangree was not able to reach the empty nest by running across one and only one vine, it would not leave its nest.*



*I had to get rid of the camoudile using only thrown fruits and a poisonous plant.*

That covered the basics of mangree manipulation. As far as offensive weapons went, I had only two: a supply of throwing fruits in the leftmost nest and a poisonous plant in the center of the playground like the one I saw in the camoudile grasslands. For the first time, I actually regretted Achenar's decision to leave his weapons behind (not that they would have done any good in the hands of an inexperienced hunter like myself).

I resolved to use the mangrees to try and lure the camoudile into the poisonous plant, then hit the camoudile with thrown fruit to cause it to hesitate long enough to inhale enough pollen to

pass out. However, in doing so, I found that only the white-haired elder mangree had a strong enough arm and good enough aim to actually hit the camoudile. So not only did I have to trick the camoudile into hitting the plant, I also had to maneuver the elder mangree into the leftmost nest so that he could throw the fruit once the camoudile was in position.

I also reacquainted myself with the sound device. The leftmost crank produced the lowest tone, and the rightmost crank produced the highest tone. If a mangree's name had a long tone in it, I turned the respective crank for two revolutions. If it was a short tone, I only turned the crank for one revolution.

### MANGREE COMMANDS

COMMAND	TONES
Call Mangree A ("Elder")	Long low, long mid
Call Mangree B ("Wide Ears")	Short mid, short low
Call Mangree C ("Tall Ears")	Long high, short mid
Call Mangree D ("One Ear Up")	Short low, long high
Attack! (Mangree in leftmost nest)	Long high, short low, short mid

**CAUTION** TIMING WAS CRUCIAL FOR THE ATTACK. I WOULD HAVE TO QUICKLY ORDER THE ATTACK AS SOON AS THE CAMOUDILE RAN PAST THE PLANT AND THE ELDER MANGREE WAS IN THE LEFTMOST NEST. IF I HESITATED IN CALLING THE ATTACK, THE CAMOUDILE WOULD FREE ITSELF OF THE PLANT AND ESCAPE ITS POISONOUS POLLEN.



After an exhausting degree of trial and error, I finally accomplished my goal by calling the following mangree commands in this order (from the mangrees' original positions):

1. Mangree D (*Short low, long high*)
2. Mangree C (*Long high, short mid*)
3. Mangree D (*Short low, long high*)
4. Mangree A (*Long low, long mid*)
5. Mangree B (*Short mid, short low*)
6. Mangree D (*Short low, long high*)
7. Mangree C (*Long high, short mid*)
8. Mangree A (*Long low, long mid*)
9. Mangree C (*Long high, short mid*)
10. Mangree D (*Short low, long high*)
11. Attack! (*Long high, short low, short mid*)



*With the camoudile knocked out, I could pass it.*

I returned to the fork in the path at the end of the footbridge. With the threat of the camoudile removed, I was able to take the right-hand path and continue my exploration.

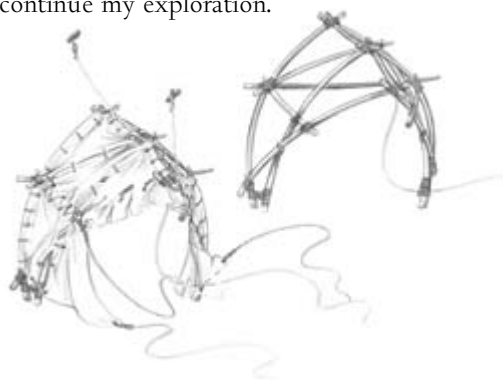



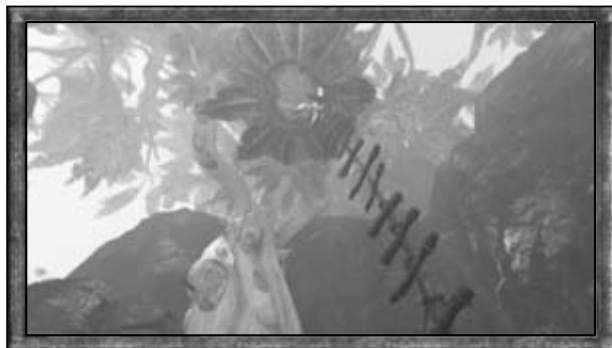

*The path ended at a mangree nest.*

The path ended at a mangree nest, with a mangree peering down at me from above. I climbed the ladder leading up to the nest to investigate it further and found that the nest actually belonged not to a mangree but to Achenar. This must have been his third living space on Haven, indicative of another personality shift toward respect for life. The mangrees in the area showed evidence of this, gathering around me without fear. These mangrees must have been the “friends” Achenar talked about having on Haven. What a remarkable difference there was between the ways in which the two brothers dealt with their imprisonment.



*Clothing from Catherine*

In the nest, I found several neatly folded shirts, presents from Catherine to her son. When I touched Yeesha’s necklace, I heard the conversation between Catherine and Achenar when she gave him the clothing. Overcome by emotion, Achenar struggled to tell his mother that he had nearly forgotten what something soft felt like.

Stretched across a pair of poles were two large, yellow leaves with crude images painted on them. With delight, I recognized the first one as the lock that Achenar had placed on the irrigation device in Serenia. But I did not understand the second one, which showed a similarly patterned snake of some description. There appeared to be some instructions on how to handle the item—or creature—but I did not fully understand them.



*The lock Achenar placed on the irrigation device.*



*I walked across a bridge made of webs and leaves.*

A bridge made of webs and leaves stretched across to an adjacent nest. When I first saw it, I thought that there was no way it could support my weight, but it was much sturdier than it looked.

### ***Life as an Omnivore***

*The behavioral differences between mangrees living on opposite sides of Haven's freshwater lake cannot be overstated here. Even today, DRC members linking to Haven often experience far less friendly interactions with the mangrees living in the north jungle—that is, those whose tribes were nearly decimated by Achenar's hunting activities—than they do with the ones who nest in the south. Apparently, 200 years of evolution have not been enough to erase the instinctive fear of mankind that Achenar's savage hunting years instilled.*

*At the same time, the willingness of the south tribe to accept humans into their homes speaks volumes about the life Achenar lived during the last seven years of his imprisonment. As his own nest inside the mangree village suggests, Achenar did not feel like a casual visitor there. He actually became one of the tribe—teaching them as much about being human as they taught him about being a mangree.*

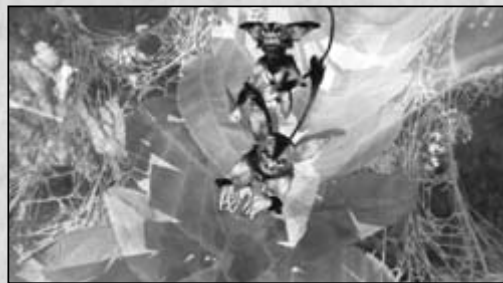



*The scene from the irrigation device vision*



*The path ended at a woven throne.*



*I rubbed the bottom-right stripe four times, right to left, then hit the snake in the face.*

As I crossed the bridge, I recognized the view as the same one from the vision I received when holding Yeesha's necklace and examining the locked irrigation device on Serenia. I knew that I was close to finding my answer.

The pathway ended at a throne woven of strips of bark. I wasn't sure what the purpose of it was, but I sat down in it—and saw another one of Achenar's striped locks on a handle at its base. I examined the lock more closely and touched Yeesha's necklace to see a vision of Achenar rubbing the lock's bottom-right stripe four times, from right to left. The "lock" uncoiled and revealed itself to be a serpent. Achenar poked the snake in the face, and it slithered away. So that was the secret.

I repeated Achenar's method, and sure enough, the same thing happened. With the serpent gone, the lever was now free. I wondered what would happen if I pulled it?



*A wild ride back to the linking point*



*I linked back to Tomahna in order to return to Serenia*

As soon as I touched the lever, a system of counterweights and pulleys started moving. Neither I nor the adventurous mangree had any time to react before the entire throne started racing along elaborately constructed bamboo rails. It deposited us in the cove near the linking chamber. The last mystery of Haven was solved—I now knew what those bamboo rails were for.

With the riddle of Achenar's lock solved, I returned to the linking chamber. Laying my hand on the Tomahna Linking Book, I began my journey back to Serenia—and hopefully to Yeesha.



## Tomahna, Part Five

//

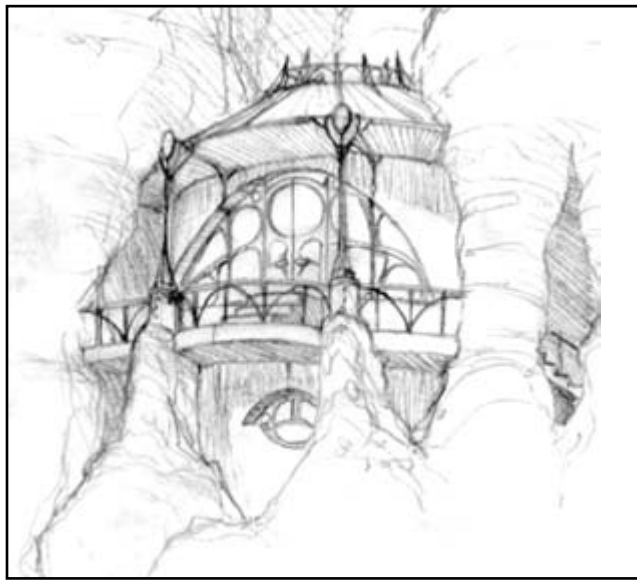

### FROM TOMAHNA TO SERENIA

The Tomahna Linking Book in Haven brought me back to the hidden linking chamber in Tomahna, just as Spire's Tomahna Linking Book had done. I pulled the handle next to the Haven Linking Book to exit the chamber. My next stop was Serenia, and I did not have any time to lose.

As I exited the hidden linking chamber and rode the fireplace elevator back up to Atrus and Catherine's bedroom, I pondered the striking differences between the way that imprisonment had affected Sirrus and Achenar, and I wondered if it had anything to do with the Ages they found themselves

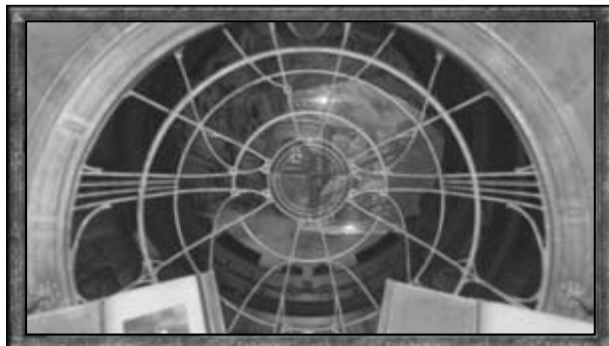

*I appeared in the linking chamber from Haven.*

trapped in. Neither one was a paradise, but Haven's lush wilderness seemed to complement Achenar's personality to a greater degree than Spire did SIRRUS's. Had SIRRUS been trapped in a more hospitable Age, would he have repented as Achenar did? Or was his treachery evidence of a fundamental flaw in his character?



*I saw a plaque on the bedroom balcony.*

simply read, "The ending has not yet been written." I was sure that it must have been there all along, but I had not noticed it until now. Reading it gave me hope that it was still possible to stop SIRRUS from carrying out his diabolical plan. Touching Yeessa's necklace allowed me to hear the echo of a conversation between Atrus and Catherine in happier times, in which Catherine thanked her husband for reminding her of the simple truth he engraved on the plaque.

I walked through Atrus and Catherine's bedroom and again noticed the half-made bed, a silent reminder of the deep rift that their sons' imprisonment had opened in their marriage. I realized that they were both right to hold their opinions. Catherine's faith in the redemption of her sons was realized in Achenar while Atrus's adherence to caution was legitimized by SIRRUS's continued betrayal.

As I left the bedroom and walked out onto the balcony, something caught my eye—a small plaque bolted to the balcony's wooden floor. It

I quickened my pace as I walked down to the elevator and entered it, setting its lever to the center position in order to return to the garden level. From there, I walked down the path through the first of Catherine's two gardens and entered her study.



*I rode the elevator to the garden level.*



*I found Catherine's journal in a desk drawer.*

I realized that I had come to fully understand everyone's perspective on the situation except Catherine's. Despite my long acquaintanceship with her husband, she was still a bit of an enigma to me. I had to correct that. I opened a desk drawer near the door to the sunroom and found her journal inside. Silently hoping that she would forgive this intrusion, I picked it up and began to read.

Catherine had linked to Haven without Atrus's knowledge before the Tomahna linking chamber had been constructed. She knew that her

husband would have objected to this "recklessness," but if Sirrus had proven anything, it was that he would find a way to escape even the most carefully constructed prison.

Inserting the linking chambers into Haven and Spire had been Catherine's idea, not Atrus's. Executing such a feat would have been unthinkable to most D'ni writers, but I remembered that Catherine always had an abstract quality to her thinking that allowed her to create Ages that the D'ni could never have imagined.

Catherine refused to excuse her sons' crimes, but she did try to explain them. When Atrus's grandmother Anna died on an Age Catherine had written, Atrus dealt with his grief by throwing himself into his work, depriving his family of the attention he had lavished upon them until that point. The boys needed guidance to help them past the pain that they also felt at Anna's sudden demise, but Atrus's grief and Catherine's guilt robbed them of the parents they needed so desperately.

As hard as it was for her to visit her sons and deal with being torn between her roles as loving mother and supportive wife, it was harder for Catherine to see Atrus visit the Prison Ages. Achenar's primal, emotional nature convinced Atrus that he had turned his son into a savage. Atrus was better able to relate to the more logical Sirrus, but he did not trust his son.

Yeesha was Atrus and Catherine's attempt at righting the wrongs of their sons. She represented their highest hopes. It was no wonder that Sirrus resented her so. Upon realizing that Yeesha had perceived the tensions between her and Atrus, Catherine decided to leave Tomahna for a few days to clear her head. Was Sirrus aware of this, and was this the reason that he chose today for his attack?

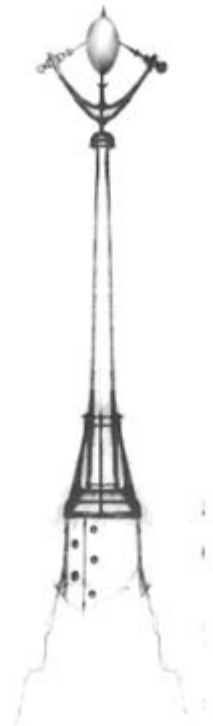



*I reached Atrus's study through the sunroom.*

I replaced Catherine's journal, glad for the opportunity to better understand her perspective on her sons. I hoped that she would not blame herself for trusting SIRRUS any more than ATRUS would blame himself for unintentionally providing the keys to SIRRUS's prison.



*I used the Serenia Linking Book*

I proceeded into the sunroom through the nearby door. From there, I continued into Atrus's study to find the Serenia Linking Book, right where I had left it. It was time to stop SIRRUS once and for all. I placed my hand on the Linking Panel and linked back to Serenia one last time.

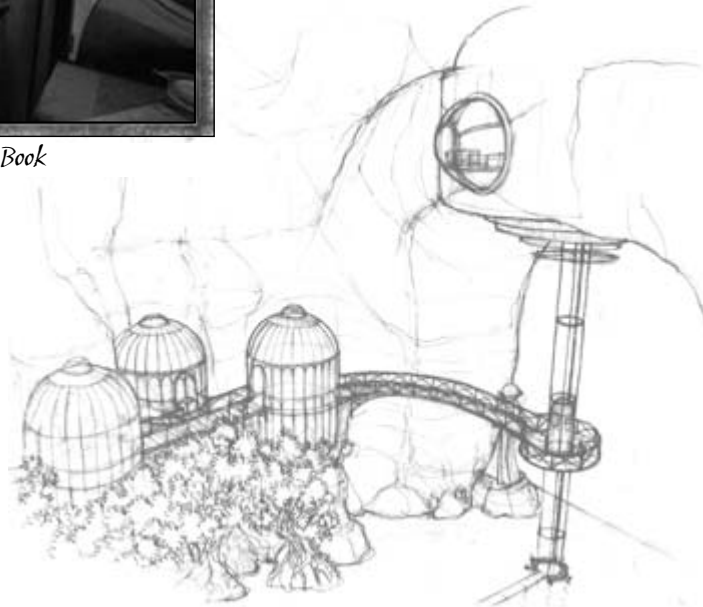



## Serenia, Part Two

//

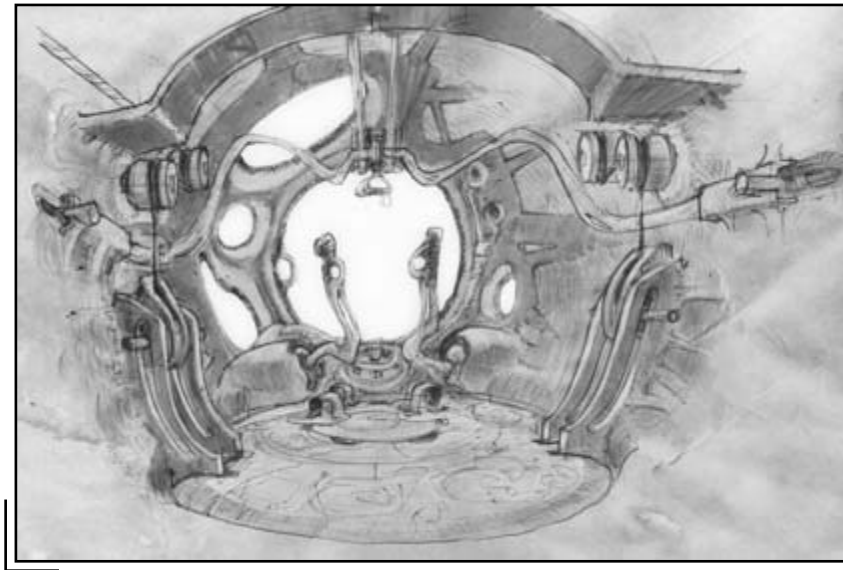

### RETURN TO SERENIA

#### Irrigation Device

From my linking point in Serenia, I traveled back through the stone forest to arrive at the locked irrigation device near the old Memory Chamber. The stone forest was as confusing and labyrinthine as I remembered it, but consulting my notes from my first visit allowed me to move through it relatively easily.

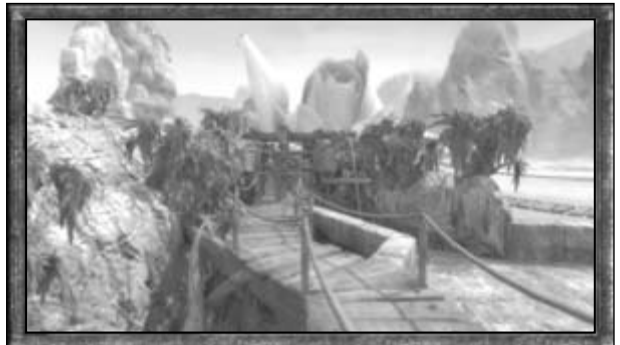

*I linked back into Serenia and returned to the locked irrigation device.*



*I rubbed the bottom-right stripe four times, right to left, then poked the snake in the face.*

When I reached the irrigation device, I used the same technique to get it to release its grip as I used on Haven. I rubbed its bottom-right stripe four times, from right to left, to awaken the creature. Once it reared its head, I poked it in the face to drive it away, leaving the irrigation device unlocked.



*I turned the wheel counterclockwise to redirect the water flow.*

With the irrigation device unlocked, I turned its wheel counterclockwise to redirect the water flow from the left stream to the right. I noted that it now seemed to flow into the underground chamber where Achenar had stolen the artifact earlier.



*The artifact chamber was now filled with water.*

Since I could no longer reach the old Memory Chamber through the now-flooded artifact chamber, I was forced to backtrack through the monastery. The only available path to the old Memory Chamber was the one leading from the stone forest across the drawbridge.

As I turned away from the irrigation device, I saw a Protector whom I had not yet met standing on the outcropping and using the signal device that overlooked the Serenian village. She was obviously upset and deeply suspicious of me because of Achenar's theft of the "life stone" from the artifact chamber. The life stone nourished the Memory Chamber and sustained it. Without that stone, the Memory Chamber would soon wither and die, and the Serenians would no longer be able to store memories or visit their ancestors. The Protector (whose name I later learned was Caradell) told me that if I was a true friend to Serenia, I would return to the Hall of Spirits and notify her sisters of the theft.



*A Protector confronted me about the theft of the "life stone."*

### **Which Came First, the Fungus or the Stone?**

The importance of the life stone to Serenia's way of life has come under close scrutiny in recent years. Oral histories brought back from the Age suggest that the first stone was discovered by a Serenian artisan. Drawn to the rock by its unique shape and texture, she decided to turn it into a piece of sculpture. To her surprise, when she cleaned her new sculpture in rivers close to her home, the village's fungus "responded with great pleasure."



Chemical analysis has since revealed that a life stone's nourishing influence comes from high levels of a unique mineral compound within it. When dissolved in water, these minerals affect the Memory Chamber like powerful vitamin supplements, increasing its energy and enabling older flowers to continue to perform memory transfers. But is the stone really vital to the functioning of the fungus itself?

Apparently, yes. Centuries of dependence on the stones have affected the fungus so greatly that it is doubtful the flower could continue to perform transfers without it. The fungus itself might survive, but Serenia's ties to its ancestors would be lost.

## Spirit Guide



*I needed to find a spirit guide to hear the ancestors' message.*

I returned to the Hall of Spirits, and one of the three dreaming Protectors (Zanika) rose up to tell me that they had been consulting with their ancestors in Serenia's "mirror realm"—a place called "Dream"—even as I had been investigating the physical world. She said that the ancestors had shown them a vision, but that the Protectors did not understand it because it was meant for me. To see the vision, I would have to go to Dream, and to visit Dream, I would need a spirit guide. If I was willing, the three Protectors would now determine which spirit guide was best suited for me.

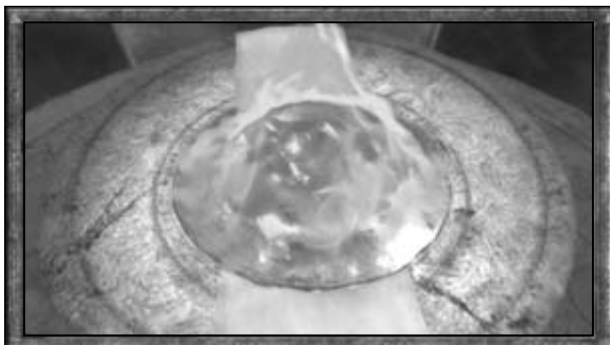

*I touched an elemental combination of fire, wind, and water to read my personality.*



*Moiri told me I was best suited to a water guide.*

An amorphous amalgamation of wind, fire, and water floated down from the ceiling of the Hall of Spirits. When it settled onto the altar in front of me, I placed my hand on it, and the reading began.

I could not say how long the reading took. When it was over, however, the Protector to my right (Moiri) stood and told me that I was most attuned to the element of water and that I needed to bring the proper offering to the water spirit guide in the stone forest.



*My first objective was to find my spirit guide in the stone forest.*

The first thing I needed to do was to find the spirit guide in the stone forest. I would have a much easier time of this once I recognized the habitats that my spirit guide preferred.

### Which Personality Are You?



*Not every individual to undergo Serenia's personality rite has emerged as a Child of Water. Some were classified as Wind Children—"attracted by challenge and diversity... Always moving swiftly to the heart of a matter, yet willing to take the time needed to understand it."*

*Still others have emerged as Children of Fire—"drawn by the excitement of new experiences... Always seeking adventure over stasis."*



*In either case, the ending of the ritual was quite different. Children of Wind saw the wind guide statue spit seed blossoms into the air before being told by the Protectors to seek their spirit companion in "the glades where pollen seeds cluster." Fire Children, on the other hand, witnessed the fire guide statue shoot flames into the air. They were then told to find their guide in Serenia's stone forest, "near the smoldering stones."*

*In all cases, a unique offering had to be made, and only one such offering was deemed acceptable by each type of guide.*



## Spirit Guide Habitats

As I quickly discovered, each type of spirit guide had its own recognizable habitat.

**Fire spirit guides** burned brightly in otherwise dimly lit torches.

**Water spirit guides** rose up from small, round pools.

**Wind spirit guides** hovered above circles of stones.



*Fire spirit guide habitat*



*Water spirit guide habitat*



*Wind spirit guide habitat*

Approaching a spirit guide without the proper offering in my hand would cause the spirit guide to vanish. And even if I brought the proper offering to a spirit guide that was not attuned to me (a fire or wind spirit guide in my case), the spirit guide would leave.



*The next objective was to find the proper offering*

Once I found the spirit guide, I kept my distance from it to avoid driving it away by approaching it without the proper offering. I scouted the surrounding area for the nearest source of the preferred offering for my spirit guide.

### Spirit Guide Offerings

From my subsequent talks with the Protectors, I found that each spirit guide preferred a specific type of offering found in the stone forest.

*Fire spirit guides preferred heated nectar.*

*Water spirit guides preferred bubbles.*

*Wind spirit guides preferred falling seed blossoms.*

To catch an offering, I held my hand out and let the offering fall into it. If I moved too quickly or waited too long while holding it, the offering would disappear, and I would have to go back for another one. Each spirit guide habitat had a source for the guide's respective offering nearby.



*Heated nectar for a fire guide*

To catch an offering, I held my hand out and let the offering fall into it. If I moved too quickly or waited too long while holding it, the offering would disappear, and I would have to go back for another one. Each spirit guide habitat had a source for the guide's respective offering nearby.



*Bubbles for a water guide*



*Falling seed blossoms for a wind guide*



*I carried the offering to the water spirit guide and held my hand out to it.*

After discovering where the water spirit guide had appeared, I found a source of bubbles a short distance away. I let a bubble fall into my hand and turned very cautiously to return to the water spirit guide. Upon reaching the water spirit guide, I extended my hand to it and presented it with the offering. The water spirit accepted the offering and vanished in a brilliant burst of light. I could not describe the feeling that accompanied this, except to say that I felt the presence of the spirit guide in my mind, reassuring me that I could now dream in the Memory Chamber.

### ***Spirit Guide Offerings: Why Only One Type Will Do***

*An interesting theory regarding the nature of Serenia's spirit guides has been circulating recently among DRC members. As it has some bearing on the types of offerings each guide accepts, it's definitely worth consideration.*

*The theory states that spirit guides are not native to Serenia; rather, they come from the Age's "mirror realm" (also known as "Dream"). Because of this, the guides have no physical form in Serenia and must make use of elements common to the Age in order to appear there. The higher the concentration of this element in any given location, the more likely it is that a spirit guide will appear there.*

*The theory goes on to state that, since spirit guides have no physical form, they typically don't have senses as we understand them. There is, however, one notable exception. Spirit guides can smell. Smells enhance the guides' contact with the physical world, enabling them to become more solid. Yet their sense of smell is limited to specific aromas dependent on the type of spirit they are.*

*Water guides can only smell sulfur-filled bubbles emitted by Serenia's geysers.*

*Fire guides can only smell pollen produced by Serenia's fire crocuses.*

*Wind guides can only smell seed petals shed by weeping blossom trees.*

*Scientists seeking to prove this theory would like to conduct additional studies on the guides, but the spirits themselves have proven too elusive to comply.*





*I returned to the Memory Chamber after finding my spirit guide.*

Zanika was waiting for me in the Memory Chamber. She told me to lie down on the stone slab and look into the stone eyes above me to enter the Dream Realm. The last thing I remember Zanika telling me was that my spirit guide would be waiting for me in its true form there.



*Zanika met me in the Memory Chamber.*



*Words cannot describe the ineffable beauty of Dream.*

## Memory Chamber

After finding the spirit guide and presenting my offering to it, I returned to the Memory Chamber and climbed the stairs inside of it to reach the dreaming alcove.

With that, I felt myself slipping away, as if I was falling asleep and awakening at the same time. I saw the spirit guides, streaking across an ethereal plane like comets in the night. My poor skills prevent me from capturing the indescribable beauty of my voyage into the Dream Realm.

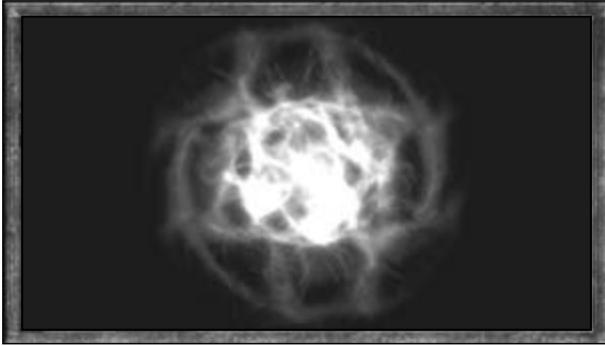

*The spirit guide told me that this was the dreamer I sought.*

My spirit guide was able to locate the mind of the dreamer I sought, and Yeesha's consciousness appeared as a glowing white sphere of light. The spirit guide said that Yeesha was a traveler with the power to shape dreams, but that she seemed to have no waking mind to return to. I shuddered—did this mean that Yeesha was...no, I couldn't even begin to consider that possibility.

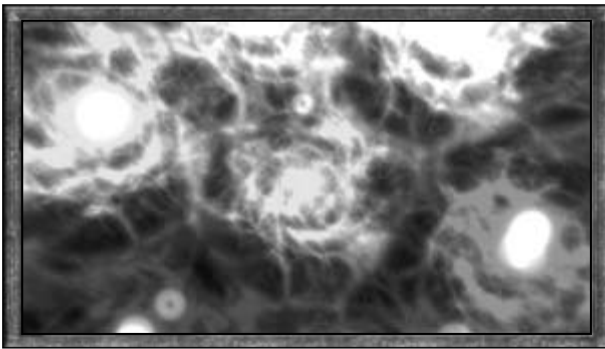

*Serenian ancestors appeared around Yeesha and surrounded me.*

Other spheres of light, representing Serenians whose memories had been stored in Dream surrounded Yeesha's consciousness. The spirit guide told me that, in order to unlock the message that Yeesha had for me, I would have to seek these ancestors' assistance by causing all of them to resonate together. In practice, this meant changing all of the multicolored floating spheres of the ancestors to match the same pure whiteness of Yeesha's consciousness.

Moving my hand over an ancestor's consciousness changed the color of it in the same order every time: red to purple to blue to light blue to green to yellow to white. Touching a white sphere changed it back to red and started the process over. Yeesha's consciousness, indistinguishable from any other white sphere, never changed color.

After touching a sphere (sphere A) and changing its color, I could move to touch any adjacent sphere (sphere B) and change its color as well. However, if I returned to sphere A from sphere B, sphere A would not change color. But if I moved from sphere A to sphere B to sphere A again and touched another sphere adjacent to sphere A (sphere C), returning to sphere A would cause all of the spheres surrounding sphere A to change colors randomly.

There was no way to describe my exact method for solving the puzzle, as I was not able to keep precise mental notes, and I did not have my physical journal with me in this ethereal realm. At any rate, I am not sure if they would have done me any good. If I understood the Protectors correctly, every person who experiences the Dream World does so in a different way, so the value of such records would be dubious at best.

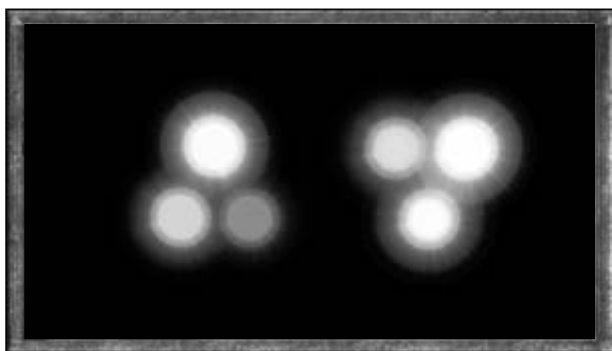

*Success showed me the additive colors of white light.*

Like all of the time I spent in the Dream Realm, I could not say how long I spent bringing the ancestors' spheres into resonance with Yeesha's. Once I did, though, I saw the vision that the Protectors had told me about, but it was almost as perplexing to me as it was to them.

The white spheres condensed themselves into two spheres, each of which split into the two triads of additive colors that made up white light—red, green and blue, yellow, purple and light blue. That explained why the ancestors' spheres appeared in only those colors.

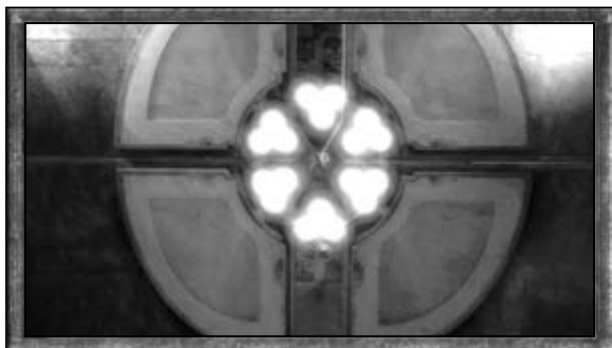

*A door—could it be the one under the old Memory Chamber?*

The six spheres turned white and multiplied threefold into six three-sphere triangles arranged in a circle. A door faded into view behind them and opened. I did not recognize the door, but there was only one on Serenia that I had not opened—the one under the old Memory Chamber. Yeesha must have been trying to tell me how to open it.



*I awoke from the dream as soon as the vision ended.*

With the good wishes of the spirit guide echoing in my ears, I opened my eyes and found myself staring up at the ceiling of the Memory Chamber. The vision was over; now it was time to see if I could put it to good use.

## Conflicting Theories of Dream

The existence of Serenia's "Dream World" continues to be a topic of great debate among DRC members today. Invariably, opinions fall into one of two camps.

The first group, known affectionately as "Atrus Theory Supporters," believes that Dream is not real. As support for their claims, they point to the fact that visitors to the realm invariably enter it from inside the Memory Chamber's second floor meditation alcove. This room sits directly above the flower's pollen-producing stamen, which has been shown to elicit hallucinogenic reactions in people. Consequently, Dream itself can be explained away as "fanciful visions" brought on by exposure to the pollen.

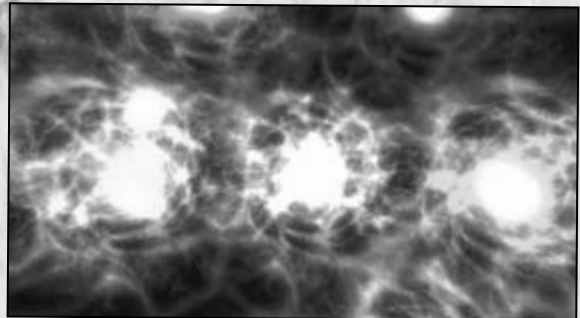

Yet if this ideology is right, claims the opposing group of theorists, then how does one explain the uncanny prescience Serenians continually exhibit, which they claim comes from their journeys in Dream?

"Yeesha Theory Supporters," as this second group is called, believe that you can't—unless you accept the fact that Dream really does exist. They believe that Serenia's "mirror realm" exists halfway between her physical and spiritual dimensions. Inhabitants of either space can and do access Dream in a number of ways. For humans, it's done through dreams and meditation. For spirits, it's in ways "not fully understood."

Certainly, both ideologies raise interesting points—a fact that will no doubt cause the debate to continue raging for years.



*Anya locked up the Memory Chamber and wished me luck.*

### Old Memory Chamber

As I left the Memory Chamber, I met Anya walking down the path. She told me that the other Protectors had left for the village, and that she was going inside the Memory Chamber to seal it until the crisis had passed. She told me that in all of the Protectors' dreams, the last task always fell to me.

**NOTE** I COULD REPLAY THIS CONVERSATION IN MY MIND WITH THE ASSISTANCE OF YEESHA'S NECKLACE BY TOUCHING IT WHILE STANDING IN FRONT OF THE LOCKED MEMORY CHAMBER DOORS.



*I left the monastery and reached the path to the old Memory Chamber via the stone forest.*

To reach the old Memory Chamber, I had to leave the monastery and return to the stone forest. From there, I found the path leading to the drawbridge and crossed it. The old Memory Chamber was just below me to my right.

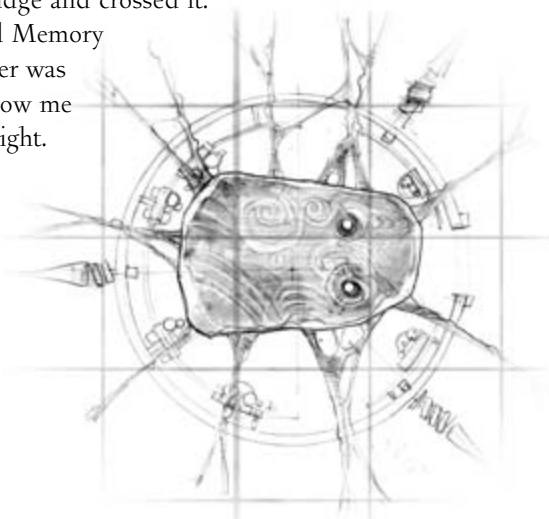

As I approached the harvester outside of the old Memory Chamber, Sirrus exited the structure through its front door. As soon as he saw me, he tried to convince me that he was working to stop Achenar's mad plot to hold Yeesha hostage and strip Serenia of its riches. He begged me to return to Tomahna and bring Atrus to Serenia so that we could maneuver Achenar into a trap.

After the evidence I had seen of Sirrus and Achenar's characters in their respective Prison Ages, I knew which brother I trusted, and it was not Sirrus. I advanced on him, and Sirrus, seeing that I was not falling for his story, scrambled back into the old Memory Chamber, locking the door behind him.

I ran to the harvester basin and saw that it was no longer being filled by the streams that lined Serenia, but the water level was still too high to reach the hidden door.

I needed to lower the water level quickly, so I closed the harvester door and lowered it into the basin to displace a large volume of water. When I raised the harvester back up, I was able to descend a set of stairs leading to a control room.



*Sirrus came out of the door to the old Memory Chamber.*



*The basin was no longer being fed by waterways, but the water level was still too high.*



*Dropping the harvester displaced water.*

I reached a large valve placed below a crude window that looked into the basin. Turning the valve clockwise opened a drain on the side of the basin and lowered the water level even further.



*I turned the valve clockwise to drain the basin.*



*I lowered the harvester with the door open and trapped water inside of it.*

The water level still was not low enough for me to reach the hidden door, so I returned to the harvester controls and lowered the harvester into the water again with its door closed, reasoning that this would push more water out through the drain. I then opened the harvester door while it was still submerged in order to fill it with water, then I closed the door and raised it up again, taking a large volume of water with it.



*I approached the locked, hidden door.*

This removed enough water from the basin for me to descend the stone stairs past the drain valve and through the now-open door at the bottom of them. On the other side of the door was the hidden door I had seen from the harvester.

I approached the hidden door and recognized it as the one from my vision in the Memory Chamber. Examining it with Yeesha's necklace showed me a flash of the amulet I found at the end of my Spire exploration, then it replayed the vision of the dancing triangles of light that I saw during my dreaming.



*I saw a vision of the amulet on Spire.*



*I pressed a button below the lock to reveal the locking mechanism.*

I pushed a button below the lock to reveal a circle of colored marbles. Touching a marble revealed the pathways it could move along, represented by grooves in the locking mechanism. From my vision, I knew that I needed to arrange the marbles into six triangles—but what was the logic behind it?

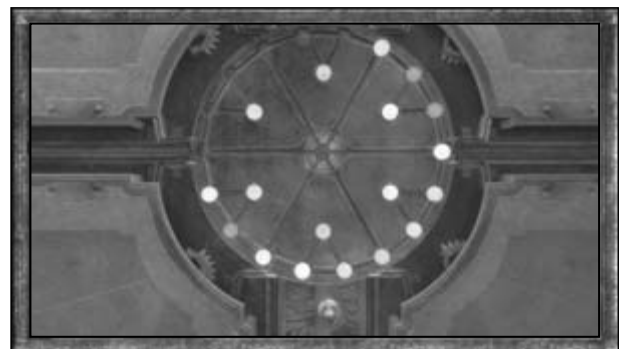

*I started by recreating the pattern from the Spire amulet*

Because Yeesha's necklace had shown me SIRRUS's amulet, I decided to recreate the pattern of six colors from the amulet along the six slots on the inner ring of the locking mechanism. This in and of itself did not open the lock, but it felt right. Perhaps Serenian mysticism was starting to influence my thought process.



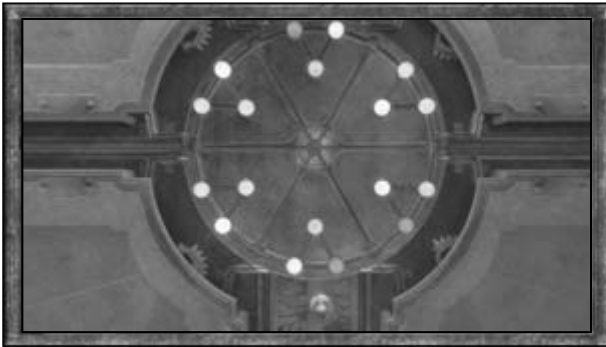

*I created triangles of marbles according to their additive properties.*

I remembered the circle of six triangles composed of three white spheres from my dream vision. That, combined with the illustration of the additive properties of the colors of light, triggered my next idea. I would arrange the remaining marbles so that I created six triangles of marbles, the colors of each of which would combine to form white light.

### Additive Properties of Colors of Light

INNER MARBLE	OUTER MARBLES
Red	Green, Blue
Green	Red, Blue
Blue	Red, Green
Purple	Light Blue, Yellow
Light Blue	Yellow, Purple
Yellow	Light Blue, Purple



*I guessed correctly.*

My logic was correct. Arranging the marbles into additive triangles of colors of light was the secret to opening the door. Pressing the button with the correct combination in place opened the door and granted me access to the brothers' former workshop.

## You Can't Unlock the Past Unless You Revisit It Yourself

*It's unfortunate that photographs of SIRRUS's amulet, taken by the stranger almost 200 years ago, have not withstood the test of time. The colors the stranger recorded seem to have faded or become distorted—so much so that explorers will not be able to access the brothers' former workshop if they use the six-color arrangement described by the stranger's travel journal in the locking mechanism's center circle.*

*In order to know which six colors to place there, explorers must travel to Spire in person and use the colors they discover personally inside SIRRUS's amulet. Apparently, no two people ever see the same arrangement. But by placing the six colors they do see inside the locking mechanism's center circle, then using additive color logic to determine the outer circle, the door will open. Even after all these years.*

### Brothers' Workshop



*The door shut and locked behind me—I was trapped.*

I had to move quickly. SIRRUS had seen me, and from all the noise I had made with the harvester and draining the basin, he must have been aware that I was trying to get into the old Memory Chamber. He did not have much time to prepare for my arrival, but as long as he held Yeesha captive, he retained the upper hand. I stepped into the brothers' workshop, and the door sealed shut behind me, trapping me inside. There was nowhere to go but forward.

Directly in front of me was a shaft with a ladder that extended up into the old Memory Chamber. Two sets of breathing apparatus hung on the wall of the shaft. I examined them with Yeesha's necklace and found that Achenar had installed fans in the old Memory Chamber that removed the need for breathing equipment.



*I found breathing apparatus in the shaft leading up.*



*I climbed the ladder and opened the trapdoor at the top.*

In the center of the workshop, the heart of the old Memory Chamber beat feebly in a compartment of the brothers' design. I pulled on a lever to open the door and stepped inside to better examine the heart, enclosed in a glass jar to isolate its toxic fumes, no doubt. Aside from the fact that Sirrus was obviously harnessing it for something, there was nothing else to see.

I climbed the nearby ladder and turned the crank at the top of it to unlock the trapdoor above me. Pushing the trapdoor open, I stepped out into the main floor of the workshop, ready for Sirrus to make his last stand against me.

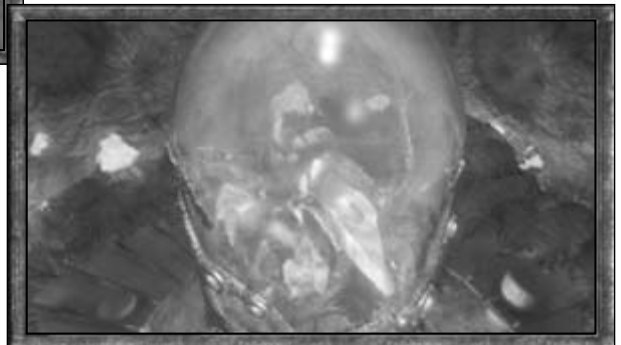

*The heart of the old Memory Chamber*



*A sarcophagus?*

Peering into the sarcophagus, I saw the dim unfocused eyes of Sirrus staring back at me. I jumped back involuntarily before steeling my nerves and taking a closer look. I could discern no movement in Sirrus's face. His pupils did not respond to light by dilating, and he was either not breathing, or his breathing was too shallow to fog up the glass window.

What could this mean? Several hoses ran from the sarcophagus to large tanks outside of it—was this a sort of life-preserving device? Had this equipment failed him, killing him after he locked himself inside of it? I had no answers, but I took some relief in knowing that Sirrus was no longer a threat.

I reached the top of the stairs and found Yeesha strapped to a chair in the middle of a room filled with mechanical equipment of every description. She heard me enter before she saw me, calling me “Achenar” before she looked up and realized her mistake. She begged me to pull a lever in the center of the room to free her.



*Sirrus, dead?*



*Yeesha was strapped down in a chair, still alive.*



*Achenar burst in and claimed that Yeesha was actually Sirrus.*

family. The fact that he removed the life stone and jeopardized the health of the Memory Chamber was evidence that Achenar was still a killer.

At this, Achenar stopped cold, put his crossbow away, and calmed his voice. He reminded me that he had only taken the life stone in order to stop Sirrus, and that I had to pull the amber lever in front of me to begin the process of giving Yeesha her memories back.



*Two levers—Yeesha's was silver; Achenar's was amber.*

I ran to the control panel and saw two levers, a silver one and an amber one. Yeesha said that Achenar had used the silver one to lock her into the chair. I was just about to pull the lever when Achenar burst into the room with a crossbow and the life stone artifact and told me to stop. I stepped back from the control panel as Achenar made an incredible claim—Sirrus had stolen Yeesha's memories and implanted his own in her, effectively taking control of her body.

Yeesha cried that Achenar was lying, that he had killed Sirrus and meant to kill the rest of their

I looked down at the levers and had to make a choice—did I pull the silver lever as Yeesha asked, or did I listen to Achenar and pull the amber one? For me, it was not a choice at all. Achenar's tale might be far-fetched, but I had seen the evidence of his redemption on Haven. My exploration of Spire only showed me that Sirrus had grown more proficient at concealing his malice. I pulled the amber lever.

It was the right choice. “My performance was perfect,” said Sirrus through Yeesha’s lips. He then leaned his head back to stare up at the ceiling. I recognized it as the technique I had used to begin my dreaming in the other Memory Chamber—Sirrus was trying to escape through the Dream World.



*“Yeesha” stared up at the ceiling and went limp.*

As Sirrus leapt into the Dream Realm, the old Memory Chamber shuddered, clearly approaching its expiration. Achenar said that he would try to use the life stone to keep the Memory Chamber going, but I would have to leap into the Dream World to save Yeesha’s memories and return them to her body.



*The old Memory Chamber was failing.*



*Was Sirrus actually dead this time?*

I followed Achenar down the stairs, asking him what he intended to do. As I passed the sarcophagus, I took another look at Sirrus through the window and found that his expression had changed. His eyes were closed, and the lights from the machines that had been keeping the sarcophagus running had dimmed, indicating that they were no longer active. Was this the end of Sirrus? I had no time to find out.



*Achenar smashed open the protective glass and inserted the life stone into the heart.*



*I sat in the chair and stared at the mask's eyes.*

I found Achenar locked in the room built around the old Memory Chamber's heart. He had broken off the door handle so that I could not follow. Telling me to go and rescue Yeesha, he smashed the protective glass dome that kept the toxic vapors from filling the chamber and placed the life stone in the center of the heart. Noxious green vapors filled the room, hiding Achenar from my sight.

I ran back up the stairs and sat in the empty chair behind the silver and amber levers. Looking up at the eyeholes of the stone mask above me, I felt myself slipping away into the dream world.

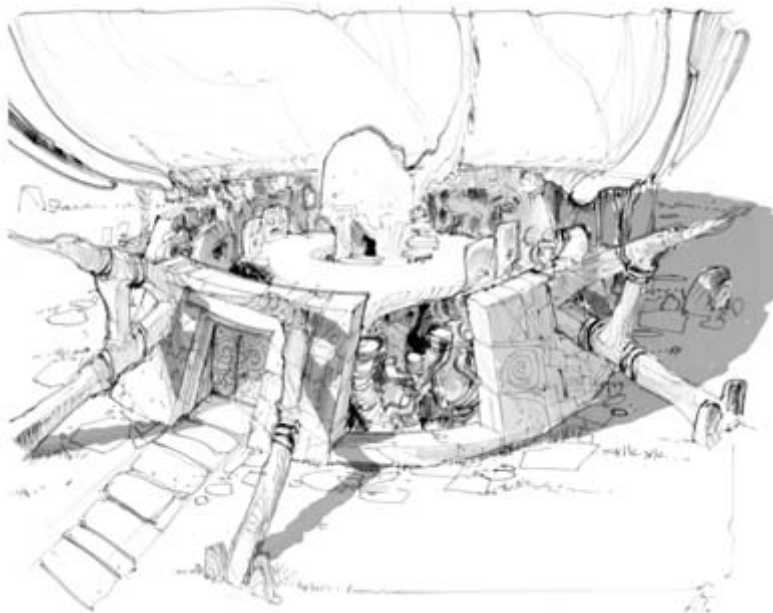

## What If the Stranger Hadn't Trusted Achenar?

Many people have speculated about what might have happened 200 years ago had the stranger chosen not to trust in Achenar's redemption. If the stranger had pulled the silver lever, as Yeesha urged, would the girl have jumped free of her restraints and caused some mishap that might have killed both Achenar and the stranger?



*Might this have happened with the wrong choice?*

Or suppose the stranger waited too long in making the decision. Might Achenar have grown too impatient and rushed forward to pull the amber lever himself, thus allowing Yeesha to somehow gain the upper hand and kill him even as he was moving?

*Thankfully, we'll never find out.*

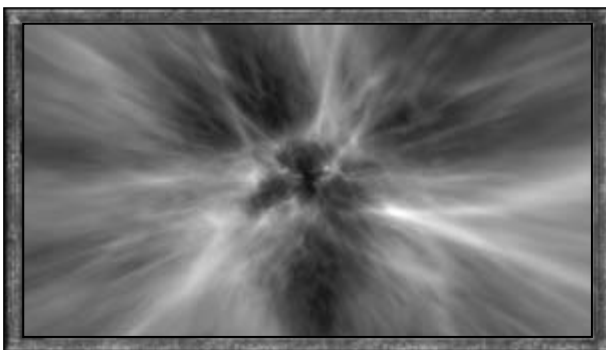

*The spirit guide once again greeted me and offered assistance.*

## Rescuing Yeesha

As soon as I arrived in the Dream Realm, my spirit guide again appeared and said that it would do whatever was within its power to help me rescue Yeesha. It explained that Yeesha was unable to return to her body because the connection between mind and body had been severed prematurely by unknown means.



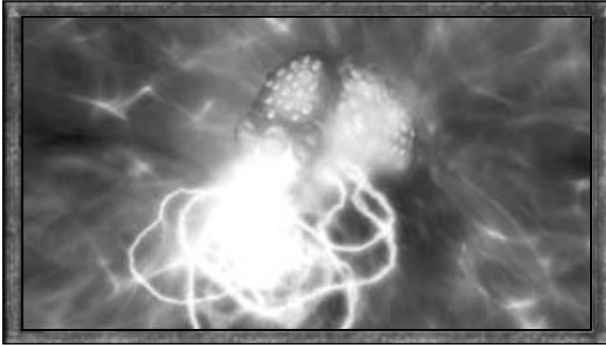

*Yeesha's dream self, held captive by Sirrus's*

The spirit guide brought me to Yeesha's dream self, which looked as if it was being fed upon by a huge insect. The spirit guide complained that the "insect" was Sirrus's dream self, and that it had ensnared Yeesha with strong bonds of memories that they both shared. If I could put straight the memories that Sirrus had used to bind his sister, I might be able to disentangle Yeesha from him and bring her memories back to her body.

To do this, I appeared in a representation of Yeesha's memory. Five objects floated in space with ten icons superimposed upon them. Touching an icon played a snippet of conversation between Yeesha and Sirrus. All of the icons put together in the right order comprised the entire conversation.

I eventually realized that I had to place all of the icons in chronological order on the objects being discussed in those particular parts of the conversation. This was not easy, as I had to take all of an object's icons at once and automatically dropped the top icon on each object that I passed.

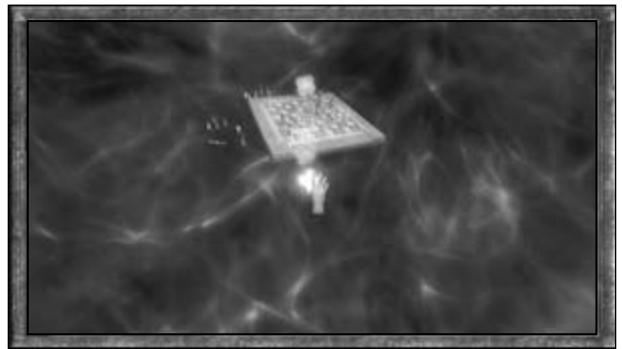

*I had to place the memories of a conversation in order on the objects being discussed.*

I found that the easiest way to accomplish my goal was to start with the object that would eventually have the most icons, clear all of the icons off of it, then move its icons onto it in chronological order. From there, I proceeded to the object that should wind up with the next greatest number of icons, and so on.

The conversation I had to restructure was the one in which Sirrus convinced Yeesha to talk Atrus into giving him the <I>nara</I> chess set. As I placed all of the fragments in the proper order on the object being discussed, the sky lit up behind the object, and I did my best to leave the icons untouched. I arranged all of the icons on their respective objects so that the conversation went as follows:

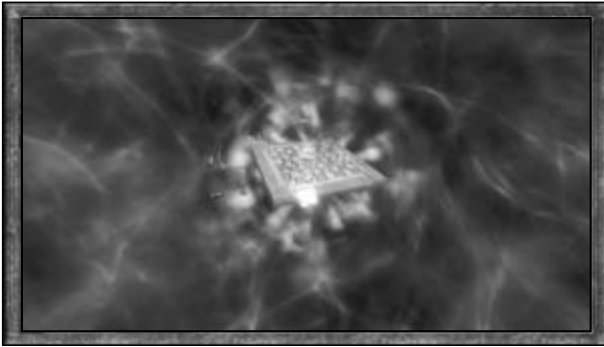

*Chess set*

*Yeesha: "Daddy's really good at chess."*

*Yeesha: "You should play him."*

*Sirrus: "I'd like to, sis, but I don't have a chess set."*

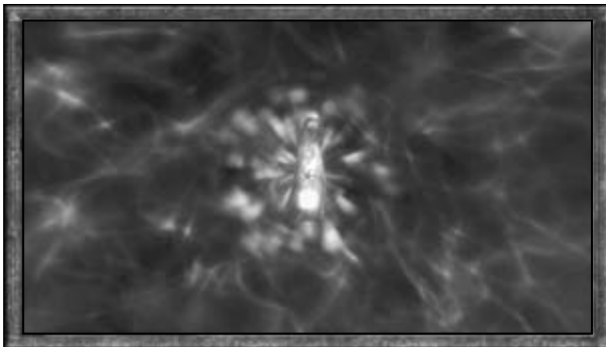

*Spirit guide figurine*

*Yeesha: "You could make one, just like you made my spirit guide."*

*Sirrus: "I could, but it's really hard to carve figurines that small."*

*Sirrus: "They break so easily."*

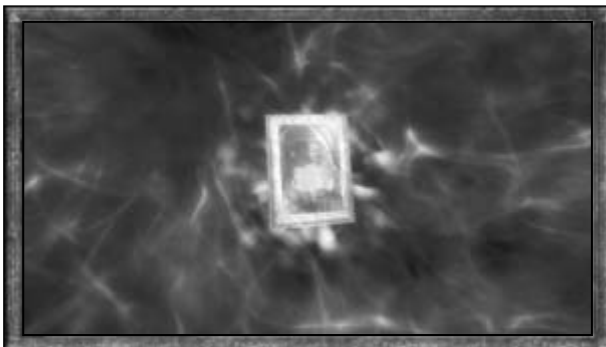

*Portrait of Catherine and Atrus*

*Yeesha: "Well, maybe Mom and Dad could give you a set, as a present."*

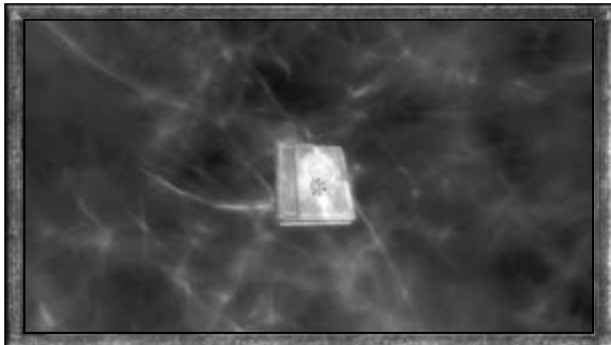

*Linking Book*

*Yeesha: "I'll tell them to when I link home."*

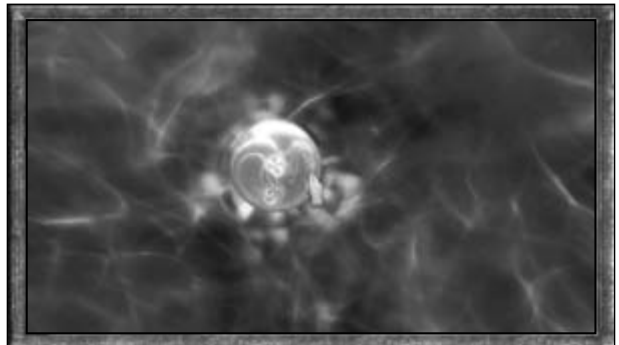

*Linking chamber door*

*Sirrus: "Right, and I suppose you'll tell them to make it out of the same rock as this chamber!"*

*Sirrus: "That way, I'll never be able to break it."*

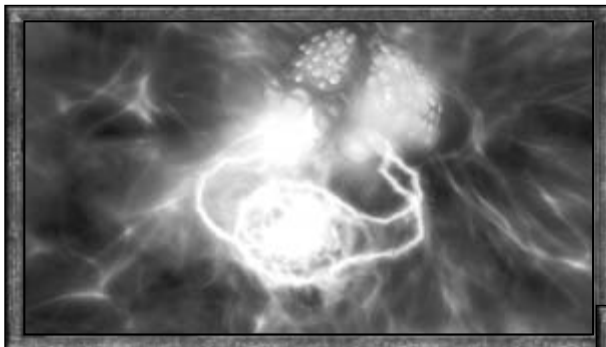

*I was winning the battle for Yeesha's memories.*

*Sirrus: "See this globe, little sister?"*

*Sirrus: "See how round and smooth and empty it is?"*

Once I finished the first puzzle, I could feel Sirrus's grip on Yeesha starting to slip. I had to solve another puzzle to break his hold completely. I did so by rearranging Sirrus's boastful speech in the old Memory Chamber atop the image of the memory globe in the workshop laboratory.

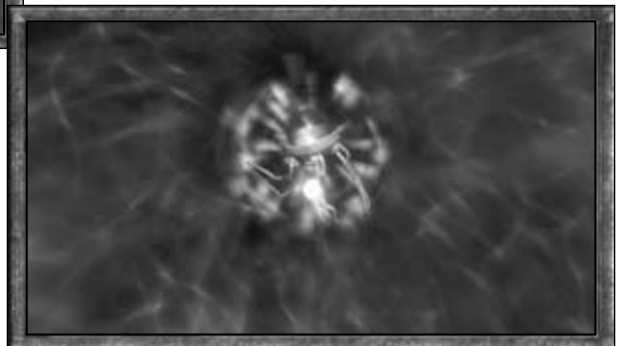

*Memory globe*



*Chair*

*Sirrus: "When I turn this switch, the chair you're sitting in will activate."*

*Sirrus: "Lights will go on."*

*Sirrus: "And everything that's you will be sucked out of your body."*

*Sirrus: "Leaving behind the perfect disguise for me to step into."*

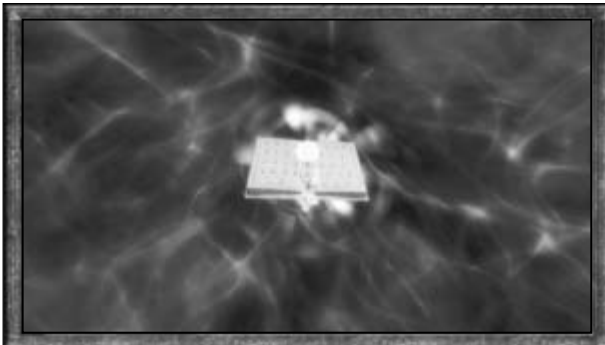

*D'ni schoolbook*

*Sirrus: "Father and mother will teach you the Art."*

*Sirrus: "Never knowing it's really me who's doing the learning."*

*Sirrus: "Of course, I'll kill them as soon as I know how to write Ages."*



*Sarcophagus*

*Sirrus: "Then I'll put my new memories back in my body, and no one will be able to stop me."*



*Sirrus lost his hold on Yeesha.*

As the final icon was placed into position in the second group of memories, Sirrus's dream self lost its grip on Yeesha's memories and flew into the void, lost for all time and doomed without a spirit guide. My own spirit guide brought me back out of the Dream Realm, assuring me that Yeesha would return to her body immediately.

### **Memory Swap or Good, Old-Fashioned Brainwashing?**

*The stranger's account of events inside Serenia's dying Memory Chamber has left some skeptics shaking their heads. Did Sirrus really succeed in transplanting his consciousness into Yeesha's body? And could he have succeeded in reversing the process once Atrus finished teaching "Yeesha" the Art?*

*Some people are inclined to say no. All Sirrus succeeded in doing, these skeptics say, was to brainwash a terrified little girl into thinking she was no longer herself. Had Yeesha returned to Tomahna in this state, Atrus might have continued to teach her the Art, but the knowledge gained would not have carried over to Sirrus if and when a reverse transfer took place. It just isn't possible.*

*But if this is true, then what really happened when the stranger traveled to Dream a second time and succeeded in freeing Yeesha's memories? Yeesha's own account indicates that the conversations between her and Sirrus, which the stranger unraveled in Dream, really did take place <I>verbatim<I>. So if a memory swap didn't occur, how was the stranger able to recount these conversations, which no one but Sirrus and Yeesha had witnessed?*

*Sirrus was most definitely mad—of that there can be no doubt. But he also exhibited signs of sheer genius during his lifetime. So perhaps the question we should be asking here is this: which version of the truth can <I>you<I> accept?*

## Endings and Beginnings

I practically leapt up from my chair as soon as I returned to the waking world. As I did, I saw Achenar leaning over the unconscious Yeesha, coughing. He explained that the only way to restore enough life to the old Memory Chamber for me to complete the transfer of Yeesha's memories was to insert the life stone directly into the heart of the shrine. Doing so released the toxic fumes that were now killing him.



*I rose from the chair to find Achenar and Yeesha.*



*Yeesha awoke.*

Yeesha awoke just in time for her brother to tell her that everything was going to be okay. His last words hung in the air as Achenar laid his head in Yeesha's lap and quietly passed from this world.

With Achenar and Sirrus dead and Yeesha safe, it was only a matter of returning to Tomahna and bringing Atrus with me to handle the arrangements for his sons and daughter.

Later, after Yeesha had left Tomahna with her mother, Atrus and I shared a quiet moment. He thanked me for my help, noting with a weary smile that he always seemed to be thanking me. As grieved as he was by the death of his sons—describing the sensation as a door closing inside him forever—he was in a way relieved that this sad chapter had finally come to a close. But as Atrus himself reminded me, endings are also beginnings, and a sad ending creates great hope for the next beginning.



*Atrus reminded me that every ending is also a beginning.*



*I left my friend to his thoughts.*

Our conversation at an end, I quietly took my leave of Tomahna. Atrus, Catherine, and Yeesha would need time to heal their wounds, but those wounds would heal, and their grief would pass. As Atrus said, endings and beginnings are one and the same, and the future remained unwritten.



# Journals

//

During my journey, I copied the text of each journal I found into my own travel journal. I found that the journals often contained hints and clues for challenges I'd soon face, even if the writers themselves did not mean to offer assistance.

## TOMAHNA JOURNALS

### Atrus's Laboratory Journal



I found this journal at the beginning of my latest adventure with Atrus and his family. It was in a drawer near the crystal tuner calibration machine in his laboratory.

*979.15 I am always surprised by how good it feels to return home after one of my journeys. In the day, heat shimmers off the cliffs, bathing me in unexpected warmth. At night gentle breezes stir the lake, and I often hear Catherine singing to Yeeshia. The sound of their voices fills me with such joy. I find myself wondering why I ever left.*

*Perhaps I am more aware of this tonight, having spent so much time alone in Rime. The trip was unavoidable. It has been weeks since I viewed Sirrus and Achenar's Prison Ages, and I needed to be assured of their safety. The Crystal Viewer did not show much, so I began considering how I might improve it. I am now fairly certain I can achieve a tighter image if I redesign the mechanism itself.*

*I have yet to tell Catherine of these plans. I do not wish to raise her hopes prematurely.*



*97.9.22* After far too brief a visit with my family, I have returned to Rime to conduct preliminary tests. The frigid temperatures in this Age are vital for the crystals to function, yet I find it increasingly difficult to work in the cold. Perhaps I can find a way to simulate extreme temperatures inside the viewer itself, so that I can install it in Tomahna when ready.

*97.10.1* Tonight I set aside experimentation for a few hours to watch the lights illuminate Rime's sky. Their beauty has not dimmed since first I saw them. I could not fully enjoy the show, however, for it put me in mind of Sirrus and Achenar, and the months we spent here constructing the towers. Soon, what had been a happy memory for me was mired in regrets.

I doubt I will ever know what caused my sons to become so greedy. I only know that when they looked at the Ages described in my library—fantastic worlds one could travel to easily, simply by touching a Book's linking panel—they saw only dreams of wealth and power. They devised a plan. An evil plan. When my back was turned, they linked to my Ages, plundered, and destroyed them.

I know Sirrus and Achenar must pay a price for these crimes, yet it brings me no joy to picture them stranded on the two uninhabited Ages I wrote to protect my library from thieves. I only hope that my sons will someday reject their wicked yearnings and find it in their hearts to reform.

*97.10.27* After experimenting with several liquid gases, I have found a pressure variable that should allow the Crystal Viewer to function in Tomahna. Tomorrow I link to Releeshahn to enlist help from the Guild of Machinists.

*98.1.10* Catherine was unusually subdued when I showed her the new blueprints. She trusts that the viewer will work, but wishes we could visit our sons in person. I would like that as well, but until I am convinced of remorse I cannot risk their escaping.

*98.4.7* I was fairly certain the evaporator coils would work and indeed, I was able to achieve a blurry image of Spire within the new viewer's blank book. Unfortunately, a more powerful suppressor is needed to stabilize the image.

Guildmaster Andritus suggested that I install several geodes inside the roof of the Observatory, then use an antenna to focus them. This should amplify the clean frequency enough so that the Crystal Viewer can work.

*98.6.29* Success! Not only was I able to view both Spire and Haven, but I also saw my laboratory on Rime quite clearly. The crystal code for Rime was difficult to remember, having not had much reason to use it previously. I must make a full list of codes soon, but for now I will keep Rime's close at hand.

*98.10.9* I always knew my sons had great potential, but today I saw something that truly amazed me. Sirrus is harnessing electricity! At least, that is what I assume, for the viewer caught a brief glimpse of something I have never before seen in his Age. It had to be a manmade construction!

*A burst of interference destabilized the image before I could study the device properly, but its existence offers proof that at least one of my sons is making the most of his confinement, rather than wallowing in despair.*

*98.10.15 The interference effect is curious. It has disrupted my viewing of Ages on more than one occasion. Although I first assumed it to be a problem with the geodes, I now believe it to be subsonic in origin. I think the roof antenna is picking up wave fluctuations emitted by one or more Ages. If this is true, I might be able to use the fluctuations to hear what is occurring in an Age. I shall have to think on this carefully.*

*99.4.26 It has been an exciting two weeks. Catherine, Yeesha, and I have just returned from Releeshahn where I spent most of my time in conversations with various Guildmasters.*

*I am now convinced that the shape and color of the crystals gives them individual resonance signatures. By combining the resonances of five crystals together, I can discover a global pattern of emissions—a sound signature, as it were—that is unique to the Age being viewed. Guildmaster Andritus assisted me in drawing up plans for a filtration panel that will enable the antenna to hone in on whatever wave fluctuations I want. I truly will be able to listen in on an Age!*

*Tomorrow I begin building the panel. I have decided to use Rime as its preset configuration, since that is the Age which first enabled me to construct a Crystal Viewer.*

*99.7.21 The panel is finished. I am too tired to test it tonight.*

*100.1.2 Catherine tried to hide it, but the sounds we heard coming from Achenar's Prison Age nearly brought her to tears. Once again I had to reassure her of his safety, and of the constructions I have witnessed that suggest he is adapting to his environment. My words eventually convinced her, but I know she longs for more substantive proof. I fear she may take matters into her own hands soon.*

*I must confess, I, too, long for more information than the viewer is currently providing. Tomorrow I shall link to Rime. I have an idea for an attachment—something akin to a "moving eye"—that will allow me to change points of view while using the Crystal Viewer. If it works, I may finally be able to see if my sons have reformed.*

### Atrus's Commentary on Spire

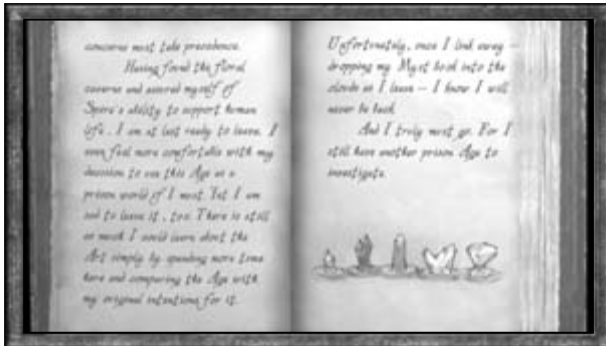

This was one of two books of commentary found in hidden panels in a desk in Atrus and Catherine's bedroom.

*Spire, I have called it. For that is the image I kept in mind as I wrote the Book that would link here. A soaring, rock-and-crystal spire rising out of dense clouds like the watchtower of some gem-studded castle. Now that I am here, and am exploring the Age in person, I find it to be exactly as I envisioned. Beautiful, yet so very deceptive.*

*From the tower formation upon which I sit, an ocean of clouds spreads out below me. Rough stone steps descend toward them, ending at an empty terrace area. Created over centuries by the erosive power of wind, these steps are so evenly matched that I almost believed they were manmade. Yet how could they be? For Spire has never had any inhabitants.*

*Steps are not the only example of how the illusion I sought to create in this Age holds true. Shortly after linking here, I walked through massive archways of stone, searching for a view beneath the clouds. As I walked, I felt as if the ghosts of a past civilization walked with me. This feeling was only enhanced by the beautiful harmonic sounds heard everywhere I went. I would have liked to determine the source of these sounds, simply for my own edification, but other concerns must take precedence.*

*Having found the flora caverns and assured myself of Spire's ability to support human life, I am at last ready to leave. I even feel more comfortable with my decision to use this Age as a prison world if I must. Yet I am sad to leave it, too. There is still so much I could learn about the Art simply by spending more time here and comparing the Age with my original intentions for it. Unfortunately, once I link away—dropping my Myst book into the clouds as I leave—I know I will never be back.*

*And I truly must go. For I still have another Prison Age to investigate.*

## Atrus's Commentary on Haven

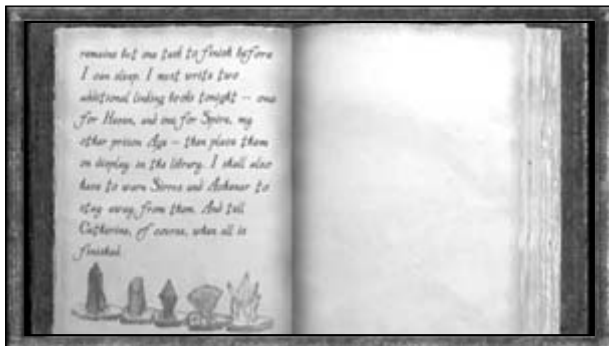

This was the other book of commentary hidden in the desk in Atrus and Catherine's bedroom.

*"Never be discouraged by a mistake, Atrus," my grandmother Anna always used to say. "Strive to learn from it instead, and you will achieve great things."*

*Today on Haven, I saw my grandmother's words become truth. The broken ship merged into the causeway near Haven's coastline is exactly what I'd hoped it would be: a promise of intrigue and adventure so palatable, it made my own heart race with excitement to see it. I thought of how much fun the boys I'd met in Stoneship Age—Emmit, Branch, and Will—would have had playing in it, and almost wished I could bring their children here to do so.*

*But Haven must remain off-limits to all, if it is to become the prison world I wrote it to be.*

*My sole foray to the Age has proved it to be capable of supporting human life, though of course none exists there at this time. Much of Haven's interior is comprised of a dense, tropical rainforest which is obviously teeming with beasts. I saw several as I explored, though they usually kept their distance.*

*A few of the fruit-eaters did stare at me curiously as I made my way under their nests. No doubt, having never encountered a human being before, they did not think to fear me. They might even have summoned the courage to become friends, had I stayed there any longer.*

*Alas I could not, for the weight of urgency was upon me. Having convinced myself of the need to protect my Myst library should some overly greedy explorer stumble onto it, I felt it necessary to link home very quickly. Taking only a few brief minutes to watch the sun set over Haven's freshwater lake, I swam out to the middle and linked away.*

*By now, the Linking Book I used will have sunk underwater and been destroyed. Consequently, there remains but one task to finish before I can sleep. I must write two additional Linking Books tonight—one for Haven, and one for Spire, my other Prison Age—then place them on display in the library. I shall also have to warn SIRRUS and Achenar to stay away from them. And tell Catherine, of course, when all is finished.*

### Yeesha's Journal



I found this journal on Yeesha's bed in her bedroom after returning from Spire.

#### *Monday*

*I got this book. Dad gave it to me. I'm going to write in it every night.*

#### *Tuesday*

*In the morning, we worked on long division. After dinner, I made a puzzle. Mom & me started the Fun Club and looked at stars.*

#### *Thursday*

*I didn't do much.*

#### *Sunday*

*We visited my brother today. He had a gift for me but Dad made me go home before I could see it. I felt bad. Dad talked to me later & said it was just bones so I shouldn't be scared. I wasn't cause I don't think Achenar meant it to be bad. He looked so sad when we left.*

#### *Monday*

*It was hot. I spent the whole day by the water.*

*Saturday*

*Dad took me to a really neat place today. It's called Serenia and the people there are sooo nice. They never forget stuff cause if they do, their Memory Chamber remembers it for them. I went inside & saw all the memory globes hanging from the ceiling, just like Sirrus said I would!*

*Monday*

*Mom said it's too soon to go back to Serenia. I've been thinking though & I don't know if I want my memories put inside a globe when I'm dead. What if I need them?*

*Thursday*

*I told both Sirrus and Achenar about the Fun Club. They want to join.*

*Wednesday*

*Dad finally said we could go see Anya tomorrow. She takes care of the Memory Chamber. She's one of its Protectors. Only women can be Protectors. Men stay in the village & do other hard stuff, like fixing roofs.*

*Thursday*

*I saw the coolest creature on Serenia today. It was made of water but when it saw me looking it got shy and fell apart. Dad said it must have been a fish jumping cause he didn't see it. Mom believed me though.*

*Friday*

*Anya told me her people put their memories in globes so their families can visit them in the Dream World. She said I could visit the Dream World too, but I'd have to learn how. PLUS I need a spirit guide. Maybe I can get one next time we visit.*

*Sunday*

*I got the best gift of all*

*time today—a spirit guide statue! Sirrus carved it for me himself. It looks kinda funny but it's cause he never saw one. He just went with what I told him. He knows exactly what questions to ask and he listens better than anyone.*

*Friday*

*Before supper Dad & me changed the lock on my bookshelf. I said since I'm learning D'ni I could change the covers and use everyone's names instead. I won't forget who's older than who, either. He said it really really had to be the really last time but he was glad.*

### Thursday

*We didn't do much but tomorrow I start learning how to dream on Serenia. I'll probably be too busy to write in this journal for months!!*

### Sunday

*Anya gave me a special necklace today! It's really good at picking up memories. She says some things are better at holding them than others & that only the most powerful memories get shown. I touched it as soon as I got home and it worked! I can't wait to show all my friends.*

## Atrus's Study Journal



This journal sat on Atrus's desk in his study. I found it after my first journey to Serenia.

*104.7.14 The first time I placed my hand on Serenia's linking panel I remember thinking, "This Age will be unlike any I have journeyed to so far." And it was.*

*The sky was crisp and clear. The rivers and waterfalls sparkled like diamonds. Even the worn paths threading through canopies of stone took my breath away. I met a group of women who told me they had been expecting me, and as we talked late into the evening they did seem to know a lot about me. Yet the more they explained why, the more impossible their stories seemed.*

*Of course. Catherine's Ages have always struck me as impossible. Why should this one have been any different?*

*One of the stories the Protectors told me (for that is what they called themselves) moves me to this day. Many lifetimes ago, a child from the village contracted a fever and died. His parents—who had loved him very much—decided to bury him under a waterfall, and built a balloon to take him there. The parents' grief was so strong, however, that when they landed their balloon they could only carry the child a short way. So they set him down beside a giant flower and slept.*

All night the mother's tears never stopped flowing. Eventually they sank through the ground and bathed the flower's roots. Moved by the tears, the flower told the parents to carry their child into her pistil. She would preserve his memories so they could visit him whenever they wished. Then the flower passed one of the tears back through her roots, turning it into a container to hold memories, and the father dove underwater to collect it. And that is how the Memory Chamber first displayed her power to the Serenians.

Having read Catherine's descriptive Book, I realize that the plant the Protectors called the "Memory Chamber" is but the fruiting body of a massive fungus. Like any fungus, it recycles dead organic material into nutrients—in this case, "filled" memory globes. Since Yeeshia has recently asked to see Serenia, I will share this explanation with her—as I did her brothers when they were her age. Yet I cannot help thinking that my scientific understanding of Serenia pales in comparison to the Protectors' simple tale.

104.7.15 I had not fully realized how many years have passed since I visited this Age, so when I stepped out of the linking cave with Yeeshia I was pleased to see only a little has changed. A new group of women have replaced the Protectors I knew, but they seem to be as friendly as the first. Yeeshia took an immediate liking to one called Anya, and as we made plans to spend more time here in the future, I felt confident our relationship with these women will be mutually beneficial.

104.9.11 After an absence of several weeks, we returned to Serenia last night. Catherine agreed to accompany us, so we will stay for a week or more.

This morning, I took advantage of Catherine's presence to re-explore alone. My route soon took me beyond Serenia's current Memory Chamber to the old abandoned flower which had served the village centuries ago.

The manmade edifice surrounding the Chamber looked much the same as I remembered, although the flower itself was in a far worse state of decay. I tried opening the door to explore inside but found it locked. Just as well. Thirty years ago, the Protectors told me how the delicate inner heart of the Chamber emits a strong fragrance as part of its reproductive cycle. The closer the Chamber gets to maturation, the more toxic this gas becomes—forcing the Protectors to find a new flower for their use. No doubt the collected fumes inside the original Chamber would have made it impossible for me to survive there very long.

105.3.10 Catherine says I should have seen it coming, but this morning Yeeshia asked permission to meet Serenia's "Ancestors." I tried to explain that the place the Protectors call Dream is not real (how can it be?!), but she insists on finding out for herself. So what am I to do?

I suppose it will do no harm to let her try. From what Anya told me, it should take several months for Yeeshia to learn how to dream. And it has certainly been awhile since I have had enough free time to concentrate on the Crystal Viewer's attachment. Keeping my inquisitive daughter occupied may end up being beneficial for us all.

105.6.10 I cannot believe how quickly time has flown—today we attended a ceremony on Serenia celebrating Yeeshia's mastery of their customs. I must admit, although my doubts about the Dream



*Realm remain, seeing my daughter's pride as she received the Protector's necklace made it all seem worthwhile.*

*105.7.2 Yeesha said something strange during our writing lesson today. She thought it was sad that Catherine rarely writes anymore, and asked if we should explain that just because someone dies after visiting an Age doesn't mean the Age's writer is responsible.*

*I knew immediately she was talking about my grandmother. Yet Catherine and I have never fully described Anna's death—so how she knew this information is a mystery. When I asked, she said her necklace had "said something" while she was holding Anna's picture.*

*The answer was completely unsatisfactory, yet I must admit Yeesha has displayed an uncanny knowledge of things she never witnessed ever since receiving the Protector's gift. I would like to examine this necklace more closely. But at the moment, the situation with Sirrus and Achenar takes precedence.*

*Perhaps after my friend leaves us tomorrow...*

### Catherine's Journal



Although I did not find this journal until late in my adventure, I believe that it was probably there all along. It was located in a drawer in Catherine's study.

*I linked to Haven yesterday. The smell of its beach washed over me long before my vision cleared.*

*With the veil of haze slowly lifting from my eyes, I forced myself to breathe very deeply. I had not told Atrus I was doing this. He would have argued with me, and told me again how dangerous it is to visit the Prison Ages before Tomahna's linking chamber is built. But construction takes time, and I could no longer wait for him.*

The sight of the shipwreck rising out of the sea filled me with unexpected dread. Of course I'd known it would be there; I'd seen it countless times in Atrus's viewer. But seeing it for real through slanted metal bars made me realize exactly what we'd done. I imagined the words my son would throw at me, and courage drained away like summer wine. I did not try to signal him.

I feel nothing but numbness now. It was my idea to write the chambers into existence—to bend the Art so that a secure room might be “inserted” in each Age, with solid walls no force of man might break. Only then could we risk visiting our sons, and leaving a Tomahna Linking Book behind us when we left.

It took me months to convince Atrus this could work. But now that the chambers exist, and I will speak to my sons for the first time in years, I find myself not knowing what to say. How will I explain our decision to leave them prisoners? If hardship and isolation have not caused them to repent, as was our hope, what words will soothe the anger in their souls?

Weeks have passed, and still I have not found the courage to link again. Perhaps it is just as well; Atrus was not pleased when he learned what I had done. He begged me to have more patience, then put extra pressure on the Guild of Stonemasons to finish. Today they informed us that Tomahna's chamber will be ready in two days. Had we been able to use the Art to create it, as we did with the ones in the Prison Ages, it would have already been finished. But things always take longer to build when you must do it by hand.

Now Atrus is looking forward to having our bedroom back. I should be too, but I keep wondering how I will be able to sleep there, knowing our sons are just a wall away. I worry how they'll act when they greet us, how different they will be from the laughing boys I remember playing with toy boats in Myst's reflection pool. They were happy then; we all were happy. Anna was still with us, and the love we shared as a family knew no bounds.

Then Anna died.

And our cozy world unraveled.

To deal with the loss of his grandmother, Atrus buried himself in work, spending less and less time with our sons. At eight years old, Sirrus must have seen this as rejection, but even then his pride was too well-formed to let it show. And as for Achenar—He'd never known how to appropriately channel his emotions.

I do not excuse the crimes committed. Sirrus and Achenar shattered so many lives, in far worse ways than Anna's death shattered ours. It's for this reason that I have stood by Atrus's decision, and left my sons imprisoned all these years. But I cannot escape my own culpability in this. For when Sirrus and Achenar needed me most, I was too consumed by sorrow to see.

I am being torn in two.

I am trapped between a mother's love for her children, and a woman's loyalty to her husband.

I don't know if I can

It is so hard! I watch Atrus and Achenar trying to communicate, and it feels like knife blades ripping through my heart. They don't know how to relate to each other. Achenar speaks only from emotions, and Atrus fears he's made his son a savage. Only my presence keeps things from fraying.

*It's easier with Sirrus; they share a love of science. And Sirrus's willingness to discuss advancements he's made ignites a similar excitement in Atrus. Yet even then, Atrus doesn't believe. He's unwilling to trust, because he knows what monsters they have been.*

*I must find a way to resolve this.*

*I must break through Atrus's doubts and get him to see what he cannot.*

*It's been a long time since I've written in this journal. I thought perhaps I had lost it, but while repotting plants in my study, I found it behind one of the incubators. It must have fallen there when Atrus reconfigured the generator.*

*No matter. I have it now.*

*Yeeshia asked me today if Atrus and I are still arguing. She was seated at the patio table, her head bowed over her schoolbooks. She was concentrating so hard on tracing a Garohervee, I don't think she saw my reaction. We have always been careful not to disagree in front of her. I should have realized how insightful she can be.*

*I watched my daughter forming the D'ni words so carefully, and I remembered how easy it had been to convince Atrus to start teaching her the Art. He never did teach Sirrus or Achenar. He started to—he wrote J'nanin specifically for that purpose. But after awhile he feared they would abuse it, so he stopped.*

*He's not worried with Yeeshia. He sees how curious she is about life, and how full of warmth she can be. It's obvious how much he adores her. As, I think, do Sirrus and Achenar. If there is any hope in this for all of us, it will be through her.*

*I must not let family tensions upset her.*

*Tomorrow I will speak to Atrus about my going to Tay for a few days. Perhaps time away will help me gain perspective and discover what it is I need to do.*

## SPIRE JOURNALS

### Sirrus's Garden Journal

This was the first of two of Sirrus's journals that I discovered on Spire. This one was written shortly after his imprisonment began.



87.5.25 *It appears that I have underestimated him. I did not think he could be this devious. He always said Spire was dangerous, but I assumed he meant its people were violent. Violent and potentially xenophobic—the perfect combination with which to orchestrate a coup. But there are no people here. No prosperous civilization for me to rule. I see now how his linking panel fooled me.*

*Congratulations, Father.*

*This hand goes to you.*

87.6.1 *I have established a temporary encampment near the vegetal cavern. The food I brought with me should last a month—after that, I will be forced to grow what I eat. The plants here are neither scrumptious nor overly abundant, but I have tasted several and find the nutrition is there.*

*Turning now to the question of escape. I believe there may yet be a Myst Linking Book here. The simplest way for Father to have disposed of it would have been to jump off the palace as he touched it. There are other ways, of course, but I cannot ignore this possibility. I must at least attempt to reach the ground.*

87.9.1 *This is fast becoming unacceptable. I have slid down every oddly-shaped "windpipe" in this Age and have yet to see below the second cloud layer. I was fairly certain that at least three of the passages would prove successful, yet even they dead-ended inside a magnificent sealed cavern full of crystals.*

*The crystals themselves are curious. Something about their inner matrix makes them susceptible to a build-up of negative charges—when I touched one, I received a terrible shock. At the same time, the faint light that had been emanating from the crystal faded, and I heard a very curious hum which ceased as soon as the crystal's charge was expended.*

*I should like to study these crystals more thoroughly, and will institute a plan to mine the cavern extensively.*

88.2.6 *Last night, I saw lights flickering in some of the other palaces. It occurred to me that I might not be alone. What if this age is like Stoneship? Father never could explain how Emmet and Branch just "appeared" there. He said the Art was always surprising him. Could it be that the lights I saw flickering were made by other people?*

*What I would give to discover this is true. After all these months of solitude, just to have another person to talk to...*

88.5.14 *About the floating rocks:*

*There is a phosphorescent green mineral running through much of this Age which exhibits strong diamagnetic properties. At least, that is the most workable hypothesis I have devised that can explain how the rocks I see outside my garden are able to float.*

*This has given me an idea. If I can capture one of the larger boulders, I should be able to turn it into a vessel, and thereby "sail" across the clouds to the nearest palace.*

*The most difficult obstacle to achieving this will be maintaining the necessary altitude...*

*I have noticed that these rocks float higher than the highest point on that palace. Forcing my ship to float lower than it prefers will take some doing.*

*88.10.2 For the past few weeks, I have been watching storms move through the second cloud layer. They appear as flashes of light inside the strata. The violence of these storms does not reach me in the garden. I encounter no rain. Barely feel the wind. I am completely safe here, nestled between layers.*

*I do not know how this is possible. How could Father have created a world which exhibits so many scientific impossibilities? He never did explain how to write an age. He never taught Achenar or I the Art.*

*I wonder now if I should have insisted.*

*89.4.18 The crystals I mined from the lower cavern are really quite remarkable. There seems to be no limit to the amount of electricity they can store.*

*Unfortunately, this makes working with them difficult. So long as a charged crystal is isolated, the energy inside it remains trapped in its matrix. But the moment the crystal even brushes against a grounded object, the stored charge flows out—producing a most amazing song. I should like to capitalize on this “singing” ability, if only as a pleasant diversion. It might be nice to hear some music in these caverns...*

*Regardless, I believe the crystals can solve my rock-ship problem. By affixing them to some of the floating rocks, then casting them back into the clouds, I should be able to harness enough of Spire’s natural electricity to fuel an electromagnet. The attractive force of the magnet, combined with the smaller magnetic fields of the lightning conductors, should be able to lower the ship and guide it to the nearest palace.*

*It is definitely worth an attempt.*

*90.10.22 Another storm is brewing as I write this. I can feel the hairs on my arms starting to rise. I am almost crazed with anticipation, waiting to test the first conductor. My god, is this what Father felt, every time his hand hovered above the panel of a Book he’d just written? Did he feel this much excitement as he stood poised to learn if his theories had worked? Why did he never share this with me?*

*If he had, perhaps things could have been different between us...*

*The first conductor is glowing. Here goes nothing.*

*91.5.25 NO NO NO NO NO!!!*

*My calculations were perfect! The ship should not have broken free!*

*The distance between conductors must be too great. I am going to have to add more to the system. But if I do, the electro-*

*magnetic pull will be too strong, and the ship will crash to the floor. So can I counterbalance it? Create a second electromagnet in the roof of the garden?*

*I am going to have to start building again. And capture another rock for a ship. This mistake has set me back years!*

*But I am close. So close to reaching the nearest palace. And from there, maybe, accessing the ground.*

*I only hope the Linking Book still works.*

### Sirrus's Bomb Factory Journal

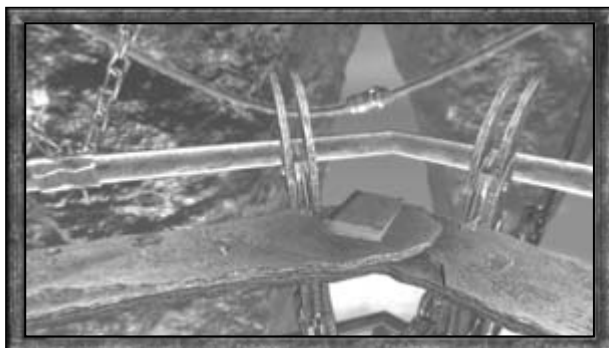

This was the second of two journals written by Sirrus and found on Spire. I discovered it in his bomb factory near the end of my explorations. It was a fairly recent journal.

*100.5.28* *Something has happened. There is a structure in the spire that was not there nine days ago, when I sailed off to harvest more metals. Its existence is... impossible. Yet I have stood inside its foyer and know that it is real...*

*I am forced to make an inconceivable deduction. Somehow, my father is still alive.*

*I do not understand how this can be. Regardless, given the design of the chamber—and in particular, its barred dividing wall—I suspect that our reunion will be tense.*

*100.8.3* *Fifteen years. Still, it is not enough for him!*

*This Age was nothing when I arrived. Nothing but floating rocks and debris. I am the one who made it livable—and I did so without help from any quarter. If I could have found just one single person to assist me...*

*But no. He does not want to talk about accomplishments. All he wants to talk about are the Books. Yes I burned them, Father. I am sorry. Now, can we put the past aside and let me out of here?*

*100.8.17 Another wasted evening, playing "repentant sinner" in his linking chamber. I do not know why I even waste my time. It is obvious he will never be convinced.*

*But what of Mother? Her endless hand-wringing is as maddening as ever, yet there must be some way I can use it. Perhaps if I play upon her guilt. Create a sculptural vignette which she can see inside their viewer. If I choose the appropriate memory, it should convince her that I, too, have my regrets.*

*100.9.29 This is intolerable!! If he did not intend to set me free, why create the chamber in the first place? To flaunt his all-powerful skill?! I get it, Father. Really, I do. Everything I have accomplished here pales in comparison to what you can do with the Art. It is the one power you have that I shall never defeat. No wonder you refused to teach it to me.*

*101.1.19 I will take this no longer. It is time I showed him some of my power. Father believes his chamber to be impenetrable, but he has forgotten the very laws he once explained to me: frequency and molecular vibration.*

*The crystals can do it. If I find the right frequency, their song can set off a vibration that will tear through the chamber on a molecular level. Those impenetrable walls will shatter like glass.*

*No doubt, I will need a great deal of electricity to do it. I had better re-tune the musical instrument.*

*101.1.29 I have a sister?!*

*I do not know what to think. It is something I never even considered.*

*I must not let it affect me. There is too much work to be done. I need to get more power to the cables. Building additional conductors will take too long, but if I dismantle parts of the rock-ship network, then rewire the remainder directly into the throne...*

*I will not be able to sail to distant palaces once I do this. But if his chamber is breached, there will be no need.*

*101.6.10 It is no use. He will never teach me the Art. Questioning him about it only makes him suspicious. Perhaps, with him out of the picture, I can learn it from the D'ni.*

*102.4.10 I cannot proceed without a sample. I have tried chipping off pieces from the chamber, using every possible method save the crystal, but my efforts have all proven fruitless. How can I convince him to give me a piece? Or better yet, a set of matching pieces...*

*This will require a very delicate touch. I wonder if he still enjoys playing.*

*103.2.14 So that was my dear little sister. I see now why he is so taken with her. She is only a child and yet... Several times during our discussion I caught her studying me, attempting to ascertain what to believe. How much have they told her, I wonder?*

*I don't even care. It's obvious they value her more than they ever did Achenar and me.  
Very well then. I shall use even that to my advantage.*

*103.8.26 Retrofitting of the old crystal cavern proceeds on schedule. The loss of my lab was a setback, for I cannot continue frequency tests until all the cavern walls are removed. But that explosion has made me very cautious: I would rather dangle over the stars than have solid rock walls explode on top of me.*

*104.7.2 NO! He cannot do this! Why is he bringing her into this?!*

*I will not allow it. I will not allow a mere child to have that much power over me. How DARE he agree to teach her the Art!!*

*There must be a way. Some way to get the knowledge from her. But how?!*

*Go ahead, Father. Go ahead and teach her. If you insist on giving this power to Yeesha, then I will make sure you're also giving it to me.*

*105.5.28 I have found the frequency...*

## SERENIA JOURNAL

---

### Achenar's Serenia Journal



This journal, written by Achenar more than 20 years ago, was hidden by its author in the stone forest of Serenia, near a point where two rivers crossed.

*Been awhile since I had this much fun working with my sick little brother. Usually we're at each other's throats by now. But this time...*



*Must be the thrill we both get, picturing Father strapped into the chair, begging us not to do what he KNOWS we're going to. Don't think anything I've done to a prisoner YET will compare with that moment.*

*Have to build the chair first though, which means getting inside Serenia's abandoned Memory Chamber. Hmmm. Can't exactly ask for a front door key, even if Sirrus DID tell the Protectors we want to study their rituals...*

*He'd just better get back from Mechanical Age with those breathing kits soon. Otherwise this whole plan is going nowhere.*

*What a hideously exhausting day. Spent so many hours working underwater I think my skin's turned permanently blue. But at least we're finally INSIDE. Sirrus wants to put a lock on our new back door—using one of his infamous marble color codes, I'm sure—but that's HIS deal. IVE still got to figure out what to do about the fumes.*

*Maybe if I...*

*First night we won't have to use the breathing kits. Of course, I'll wait for Sirrus to take HIS off first. Just to be sure. Then start hauling in materials.*

*Never seen little brother this keyed up before. But like I told him last night, getting the chair up and running is gonna take time.*

*In theory, all it has to do is stimulate the old fungus into doing what it wants to do naturally: remove a person's memories. But in order for our ENTIRE plan to work, we have to keep Father's body ALIVE before, during, and after the process so one of us can use it later. I'm not even sure the fungus will be able to remove memories from a living body. No matter how much "persuasion" it gets.*

*Decided to let Sirrus work on getting the chair operational while I start installing the life tanks. Still think this aspect of the plan is iffy but then, I don't intend to be the one who tests them.*

*Sirrus is a genius. Not sure how he did it, but judging from the results of his first test today, looks like he did.*

*Almost felt sorry for the mouse.*

*Okay, okay already! Just how many of these tests does he want to complete before we actually DO something?! Doesn't he realize that the longer we wait, the more likely it is some Protector will catch on that something's wrong? One whole part of what we're doing takes place inside their Dream World. They're GOING to see it eventually!*

*Let's stop wasting time here and instead concentrate on setting up the "bait" we need to lure Father into his cell.*

*LET'S SEND MOTHER TO RIVEN ALREADY!*

*Getting REAL nervous now. The only thing that keeps me from panicking completely is this—I know Serenia's weakness. The life stone. They'll be lost without their life stone.*

*Sure it'll take a few days, but if I steal it out of the Root Chamber, the fungus will eventually lose its ability to remove memories. And if that happens, Serenia's civilization will be thrown into total chaos. Might be fun to see it happen.*

*But it also means our plan against Father will be ruined. So I'll do it, but only if it becomes necessary to cut and run.*

*HORRIBLE fight with Sirrus today. All I did was MENTION taking the stone and he was all over me. Accused me of letting my "insatiable desire for instant gratification" screw up yet another one of his plans. Then he tried to lay the whole Narayan civil war debacle on ME. Almost belted him right then and there.*

*But the fight did show me one thing—my little brother really IS a back-stabbing weasel. These tests he keeps doing? There's only one conclusion they're heading to.*

*Screw you, little brother. There's absolutely NO WAY I'm gonna sit in that chair for you.*

*I AM OUTTA HERE.*

## HAVEN JOURNALS

### Achenar's Shipwreck Journal



This was the first of two of Achenar's journals that I found on Haven. It was written at the start of his imprisonment, and the age of the journal and Haven's harsh climate resulted in many of the words being rendered illegible.

*I cannot believe I resisted linking here for so long. Father's warning kept me away—he said Haven was an Age of great wealth, but visiting it would be dangerous without him. Lying serpent. Should have known he would say anything to keep Sirrus and me under his control. I despise him!*

*But look, father. Look who's under whose control now?!*

*Stinking rain has not let up much since I arrived. It gets almost too quiet when it does, except for the distant screams of animals. Wonder what exists beyond those cliffs? Too wet to find out tonight, but there should be plenty of time for treasure-hunting tomorrow. Judging by the chests in this wreck, I will not be disappointed. Oh, but won't Sirrus be enraged when he sees I got all the emeralds first?!*

*Been slashing through the jungle all week and have yet to run into any people. What did you do, Father? Get them to turn this island into some kind of wild animal park? It would be just like you to convince the stupid idiots to do that.*

*Have to hand it to you, though. The heads on some of these beasts will look really good on my walls.*

*Got my first taste of primate today. I was cutting a path through the jungle when one of the stupid buggers clonked me from behind with a piece of fruit! Scared the hell out of me. I whipped around, ready to slice-n-dice, but it let out this ear-piercing shriek. Must have been a signal to its buddies 'cause they all took off into their nests. Too bad Mister Shrieker wasn't fast enough.*

*Man, is it hot!! Actually starting to like these infernal thunder-storms. They ruin a good day of hunting, but at least they cool things down for a while.*

*Surprised my greedy brother hasn't shown up yet. He's got to know I skipped out on him in Serenia, after we called that little "truce." He's insane if he thinks his plan there will work. We should just kill father and be done with it.*

*Then again, maybe I should link back to Myst and convince Sirrus to set the old man free here in Haven. After all these weeks of practice, my hunting and tracking skills have really improved.*

*no way no way no way It's not GOT to be here somewhere. GOT TO BE!!! But I've searched & searched & evrywhe  
WHERE'S THE BLASTED LINKING BOOK?!!!!*

*Have to pl pull myself together. Come up with a plan. That's what Sirrus would do, isn't it? He*

*WHERE THE HELL IS SIRRUS?! @?!!*

*Doesn't matter. Need a base. Someplace to hole up in. Some stnki*

*STOP IT!! THINK.*

*The ship. It'll do for now. Till I build something better. GOT to be easier to get into, though. Es Easier, but protected against intruders.*

*Got to protect myself, right?*

*Good. That's good. That's*

*I'M GONNA KILL YOU FOR THIS OLD MAN!!!!*

*slashed at the*

*blood spurting*

*need better spear*

*wind tunnel*

*cessful day today. Mostly karnaks.*

*Figuring out how to use their fishing habits against them was sheer genius.*

*Can't escape. I must*

*wrongful imprisonment. B*

*WHERE IS SIRRUS?!*

*Miserable camondile! B!*

*nearly ripped my leg off*

*pulled vanishing act &*

*Just wait till hunting post is finished.*

*figured it out!*

*wicked brother*

*ing tongue of snake*

*tricked me with truce*

*Serenia.*

*Sirrus is trapped too! While I*

*machines, he linked to Spire in*

*search of plunder! SPIRE!! FATHER'S OTHER DANGEROUS AGE!*

*Past few days, too much blood*

*don't remember killing so m*

*Is something else here? Some  
big. 2nd predator, hunting*

*Why haven't I seen it yet?*

*more tracks. Rain washed most  
found them, but definitely tracks.  
Sneaky bastard. Think he waits*

*fifth kill site. Looked fresh, only  
smelled me coming & took off.*

*WHAT IS THIS THING?*

*MY GOD! The SIZE! IMPOSSIBLE!!  
Hands still shaking. Didn't expect attack. Didn't realize*

*MAGNIFICENT!!*

*STILL see him rearing out of sea. Water spilling down gills. Such MALICE! Such DEATH in his eyes! Sun sinking behind.  
Reflections so bright, nearly blinded.*

*Must've planned it that way. Must've KNOWN.*

*But I'm alive, sea spawn. STILL ALIVE!!! And I will defeat you. As DEATH is my witness, I SHALL DECORATE MY  
KINGDOM WITH YOUR BONES!!!*

## Achenar's Lake House Journal



This was the second of two journals written by Achenar and found in Haven. I estimate that it was written 5-10 years before his imprisonment came to an end.

*Not sure I can do this. Pen feels awkward. Keeps slipping. Been so long since I used I. But what else is there? What else to do?*

*Went back to Wreck today. First time since moving into house. Found His bones exactly how I left em. 'Cept clean now. Bleached white by the sea.*

*How many times have I replayed it since then? Sun sinking into the waves. Tip of my spear gleaming wet with the poison. See myself crouching low near the rocks. So SURE He will come. Because of His mate.*

*Sometimes—in my head—it happens different. Poison gets diluted. Or 1 of her ropes snaps & breaks. He rears back. Spear misses. Somehow they both get away. And we all get 1 more day worth living for.*

---

*Reset traps today. Swamp water corroded 1 of em. Forced to go to depot to fix*

*Coming back saw a camouaile take down a zeftyr. Moved with such precision. Not a single gesture wasted. Zeftyr probably didn't feel a thing.*

---

*It's not what I expected. Living lakeside. It's calmer. Not as windy. But rain still beats down like in the Wreck. And it's hot. Still hot.*

*Only real difference is the Screams. Lot closer now. On all sides. Starting to get on my nerves.*

---

*Can't sleep. Too many screams. And when I close my eyes, the Things I see. The faces.*

*My god, Sirrus. Did we really kill so many??*

*Added it up. Best I could. 8 years. 3 since I killed the last cerpatee.*

*Keep thinking I should do something for Him. Place some kind of tribute next to the bones. Totem pole, maybe. God knows, carving it would keep me busy for awhile.*

*Maybe I can make 1 for each of them.*

---

*What's the use? What's the use? Can't go on like this. Can't THINK!!*

*Have to do something. Keep my mind OFF the dreams. Maybe—maybe go south a few days. Sleep outside.*

---

*My god, Father. Did it have to be the same?! Two weeks working my way through the South Jungle and for what? More of the same. More of the same empty NOTHINGNESS*

*Can't take it any more. Can't LIVE like this!!!*

*Karnaks got in while I was away. Forgot how agile they are. Braver, too, when they're hunting in groups. Been breeding like mad, ever since I killed their primary predator. Should probably do something about that.*

*But maybe I can redesign 1 end of the bridge. Create some kind of lock to keep them out.*

---

*Went back to the south jungle today. Hoping I'd missed something. Saw a group of mangrees playing under their nests. Thought about replenishing supplies, but couldn't do it. They just looked too peaceful.*

*Eventually turned to go, and spied one of them watching me. Their lookout, I suppose. Wonder how long he knew I was there?*

---

*Ink supply getting low. Watering it down, but might try to make more. The way the Channelwood tree-dwellers once taught me.*

---

*Found some petals in the south jungle that might work for the ink. Picked a few to take back as an experiment.*

*While picking them, I noticed something odd about the mangrees. In the north they all scatter, soon as they spot me. But the south tribe only looks curious.*

*Must be because I never hunted them.*

---

*New ink seems okay. Would prefer a better color, though. I'll head back to the south jungle in the morning. See if I can find different varieties.*

*I don't believe it!! Went back to gather more petals and found a bunch of em already picked. They were lying in a pile where I'd been working!*

*Mangrees MUST have done it. Imitating me?*

---

*Spent most of the morning in the watchtower, trying to observe from a distance. Find out how they act when I'm not there. Couldn't see much, though. Trees are too thick.*

*WOULD like to get closer somehow. I suppose I could build another post, but it'd have to be different this time. Not a lot left I can take from the Wreck.*

*Kinda like the idea of going all natural.*

---

*How the HECK did Saavedro's people do it?! Been weaving support branches all day and my arms & chest muscles are killing me!*

*Mangrees sure got a kick out of watching, though. 1 of em even stopped playing long enough to come over & give me advice. Least that's how it seemed. Wouldn't stop chirruping at me! Made me want to rig up another sound system, see if I can try and talk back.*

---

*Oh my god. It can't be. It CANT.*

*This evening, I was sketching in the post. Trying to get their expressions right. Mangrees were playing that game they like to play. Fruit-tossing.*

*Ball must've rolled under the post. All of a sudden I heard this cry I'd never heard before. Sequence of drawn-out highs and lows. Looked up & found all of em looking at me. Pointing at the ball and making that sound. Like they were calling a name. MY name.*

*THEY'VE GIVEN ME A NAME!*

*What am I supposed to do with this, Father?! What am I supposed to do?3*